



- 01 - - 02 - - 03 - - 04 - - 05 - - 06 - - 07 - - 08 -

Pumps

- Stainless Steel Vertical Multistage Pump
- Stainless Steel Horizontal Multistage Pump
- Stainless Steel Multistage Pump
- Semi-open Impeller Stainless Steel Centrifugal Pump
- Stainless Steel Standard Centrifugal Pump
- Pressure Booster System

 LEO GROUP PUMP(ZHEJIANG) CO.,LTD. (Stock code: 002131)

2019 VI.1

No.1, 3rd Street, East Industry Center, Wenling, Zhejiang, China, 317511
Tel: +86-576-8998 6360 Fax: +86-576-8998 9898 E-mail: export@leogroup.cn www.leogroup.cn

www.leogroup.cn

LEO GROUP PUMP(ZHEJIANG) CO.,LTD.



www.leogroup.cn

HISTORY

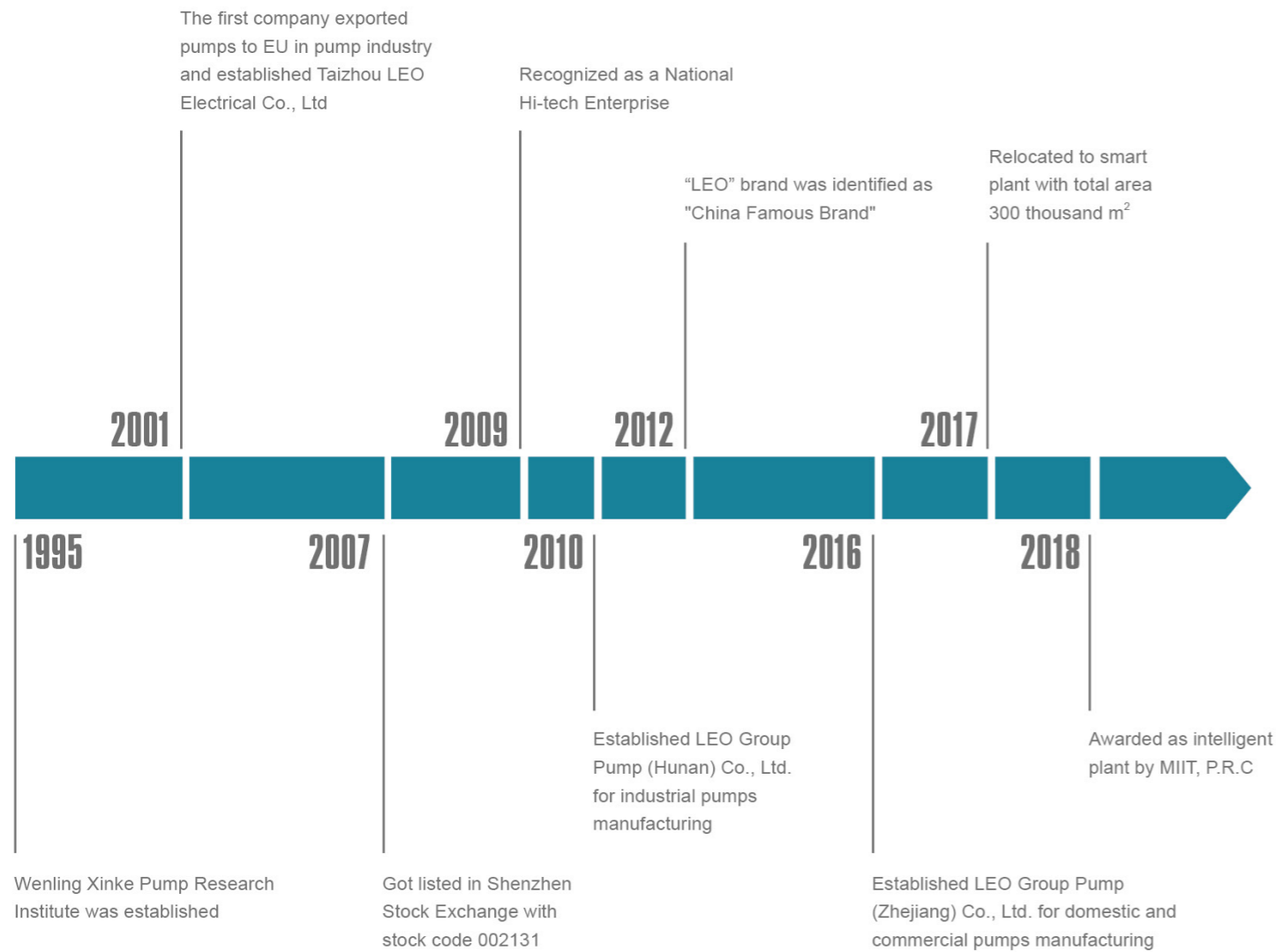

TO KNOW LEO

LEO Group (got listed in Shenzhen Stock Exchange with stock code 002131) is a national high-tech enterprise engaged in R&D, design, manufacture, sales and service of all series pumps and systems. LEO is the first listed company in Chinese pump industry, one of the drafters of pump industry standard and the vice president of drainage and irrigation machinery branch of China Agricultural machinery industry association as well. "LEO" has been identified as "China Famous Brand" by the State Administration of Industry and Commerce. It is mentionable that LEO has the only state-authorized technical center in pump industry.

We have set up many production and sales subsidiaries in key regional markets such as America, Hungary, Belgium, Thailand, Indonesia, United Arab Emirates and Bangladesh and authorized exclusive distribution agency in over 100 countries.

Our products have been sold to over 140 countries and regions, such as Europe, North America, Central & South America, Southeast Asia, Middle East, Africa, Oceania, etc., which play a crucial role in water conservancy, water resources, electric power construction, petrochemical industry, mining, metallurgy, fire-fighting, HVAC (Heating, Ventilation and Air Conditioning), agricultural irrigation, civil water supply and drainage, etc.

LEO has currently two industrial groups respectively for industrial and civilian applications. With four manufacturing bases in Wenling of Zhejiang, Xiangtan of Hunan, Wuxi of Jiangsu and Dalian of Liaoning, LEO possesses a solid foundation to become a world-class pump and system solution provider rapidly.

With over 70 years' professional technology, LEO will continue her consistent creativity and development ability in each pump for human's health.



NUMEROUS MEMBERS, ONE FAMILY

Based on market segment, LEO's pump business is divided into 5 fields, namely water conservancy & water resources, power station, petrochemical industry, mining & metallurgical industry and civilian applications. For each field there's a professional manufacturing base with relevant professional sales teams. Three subsidiary companies, Wuxi LEO Xi Pump, LEO Group Pump (Hunan) and Dalian LEO Pump are all well-known industrial pump manufacturers in their own fields. With over 70 years' industrial pump manufacturing experience and extraordinary comprehensive strength, LEO has become a leading company among all industrial pump manufacturers in China.



Pump Manufacturing Base for Domestic and Commercial Applications (Wenling City, Zhejiang Province)

LEO Group Pump (Zhejiang) Co., Ltd, a wholly-owned subsidiary of LEO Group Co., Ltd, is the core base for R&D, manufacturing, sales and service of domestic and commercial pumps for family water supply, pipeline boosting, garden and field irrigation, HVAC, etc.

The leading products include peripheral pump, jet pump, centrifugal pump, garden submersible pump, fountain pump, pool pump, doestic lifting station, gasoline engine pump, diesel engine pump, submersible pump, submersible borehole pump, submersible sewage pump, stainless steel vertical multistage pump, etc.

The product range covers 15 series with over 2,000 specifications, which are well sold in more than 120 countries and regions. The base has established steady cooperative relationships with world-class pump manufacturers, importers, dealers and hypermarkets.



Pump Manufacturing Base for General Industrial Pumps (Xiangtan City, Hunan Province)

Established in 2010, LEO Group Pump (Hunan) Co., Ltd. is a wholly-owned subsidiary by LEO Group Co., Ltd. Located in Jiuhua Economic Development Zone of Xiangtan City, Hunan Province. Covers an area of 85,000m² and construction area is about 92,635 m² with total investment of approximately 74 million dollars. It is the most important R&D, manufacturing and testing center of LEO Group. The leading products include large mixed flow and axial flow pump (vertical, horizontal, oblique, tubular, submersible etc.), double-suction centrifugal pump, multistage centrifugal pump, slurry pump, desulphurization pump and submersible centrifugal pump. Products are mainly used in mine, metallurgy, coal washing, FGD, municipal water etc.



Pump Manufacturing Base for Water Conservancy & Water Resources (Wuxi City, Jiangsu Province)

Formerly known as Wuxi Xi Pump Manufacturing Co., Ltd., a well-known manufacturer of water conservancy, is specialized in large and medium-sized pumps production for urban water supply and drainage, farmland irrigation, water conservancy projects and large water diversion project. The main products cover 32 series with nearly 1000 specifications. Products exported to more than 20 countries in Asia, Latin-America, Europe and Oceania.

As a main supplier, the base provides large pumps for South-to-North Water Diversion Project—a national key project. There are over 140 technicians, including 1 professor level senior engineer, 16 senior engineers, and 39 engineers.



Pump Manufacturing Base for Petrochemical Industry (Dalian City, Liaoning Province)

It is the pump manufacturing base for petrochemical industry, combined with Dalian LEO Huaneng Pump Co., Ltd and LEO (Dalian) Industrial Pump Technology Center Co., Ltd.

Formerly known as Dalian Huaneng Corrosion-Resistant Pump Works, the base is specialized in production of petrochemical pumps for crude oil transportation, crude oil refinery, heavy chemical industry, coal chemical industry and fine chemistry, etc. The base focuses on design and manufacture of 30 series (OH, BB, VS, etc.) of petrochemical pumps with over 3000 specifications, which are in accordance with API and ISO standard.

LEO (Dalian) Industrial Pump Technology Center Co., Ltd. is one of the research branch of national level technology center for petrochemical pumps, specializes in R&D, design of pumps of petro chemistry, coal chemical industry, long-distance transport pipes, energy resources, fine chemicals industry, etc. Design and develop software and large laboratories, explore liquid transport schemes under severe conditions and solve the difficult projects of ultralow temperature, high temperature, high pressure, low cavitation, highly corrosive, energy recovery, etc.



Application

- Suitable for transferring liquids of low viscosity, non-inflammable and non-explosive, not containing solid particles or fibers
- Water supply & drainage for high-rise buildings, filtration and transfer at waterworks, pressure boosting in main pipe
- Washing and cleaning systems, boiler feeding, cooling water circulation, water treatment systems, auxiliary system, support equipment
- Ultra-filtration systems, reverse-osmosis systems, distillation systems, separators, swimming pools
- Agricultural irrigation: sprinkler irrigation, drip-feed irrigation
- Food & beverage industry
- Fire-fighting system

Operating Conditions

- Low viscosity, non-inflammable and non-explosive liquids not containing solid particles or fibers. The liquids must not chemically attack the pump materials. When pumping liquids with a density or viscosity is higher than that of water, a motor with a higher output power rating shall be used.
- Liquid temperature: -20°C~+120°C
- Flow ranges: 0.7-240 m³/h
- Liquid pH value: 4 - 10
- Max. ambient temperature: +40°C
- Max. operation pressure: 33 bar
- Altitude: up to 1000 m

Motor

- IE 2 motor (IE 3 motor optional)
- Totally enclosed & fan-cooled
- Protection class: IP55
- Standard voltage: 50Hz 1 x 220V/3 x 380V

Identification Codes

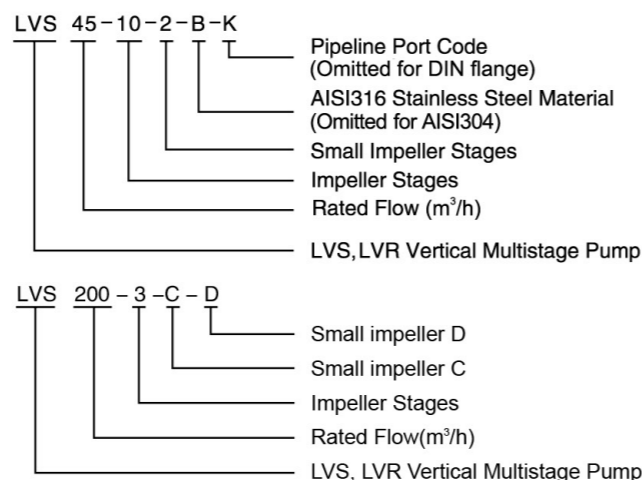

LVS: Stainless steel wetted parts
LVR: Cast iron base & pump cover

Identifications codes of flange structure

A: Oval flange; K: Clamp connector ;
G: Threaded connector

Ambient Temperature

Max. ambient temperature: +40°C. Ambient temperature above 40°C or installation at altitude of more than 1000 meters above sea level require the use of an oversize motor. Because of low air density and poor cooling effects, the motor output power P₂ will be decreased. See the picture.

In such cases, it may be necessary to use a motor with a higher output power rating.

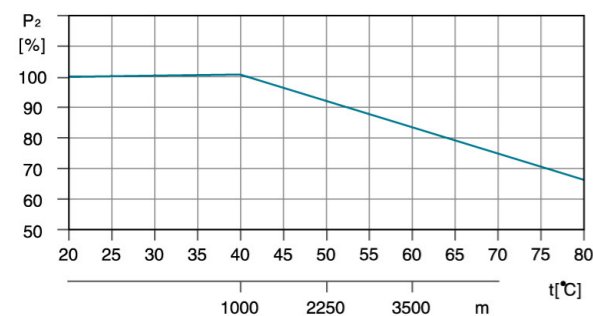

For example, when the pump is installed at altitude of more than 3500 meters above sea level, P₂ will be decreased to 88%. When the ambient temperature is 70°C, P₂ will be decreased to 78%.

Minimum Inlet Pressure-Npsh

Calculation of the inlet pressure "H" is recommended in these situations:

- The liquid temperature is high.
- The flow is significantly higher than the rated flow.
- Water is drawn from depths.
- Water is drawn through long pipes.
- Inlet conditions are poor.

To avoid cavitation, make sure that there is a minimum pressure on the suction side of the pump. The maximum suction lift "H" in meters head can be calculated as follows:

- $H = P_b \times 10.2 - NPSH - H_f - H_v - H_s$
- P_b = Barometric pressure in bar. (Barometric pressure can be set to 1 bar). In closed systems, P_b indicates the system pressure in bar.
- NPSH** = Net Positive Suction Head in meters head. (To be read from the NPSH curve at the highest flow the pump will be delivering.)
- H_f = Friction loss in suction pipe in meters head. (At the highest flow the pump will be delivering.)
- H_v = Vapor pressure in meters head. (To be read from the vapor pressure scale. "H_v" depends on the liquid temperature "t_m")
- H_s = Safety margin=minimum 0.5 meters head.

If the "H" calculated is positive, the pump can operate at a suction lift of maximum "H" meters head.
If the "H" calculated is negative, an inlet pressure of minimum "H" meters head is required.

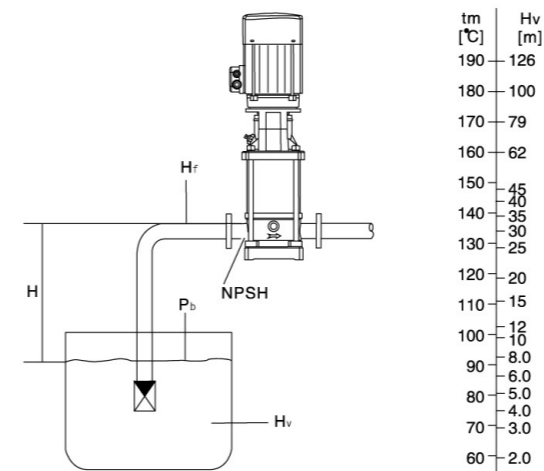

Note: To avoid cavitation, never select a pump with a duty point too far to the right on the NPSH curve. Always check the NPSH value of the pump at the highest possible flow.

Maximum Inlet Pressure

The following table shows the maximum permissible inlet pressure. However, the current inlet pressure + the pressure against a closed valve must always be lower than the Max. permissible operating pressure.
If the maximum permissible operating pressure is exceeded, the bearing in the motor may be damaged and the life of the shaft seal reduced.

Model	Max. Inlet Pressure [bar]
LVR(S) 1-2 - 1-36	10
LVR(S) 2-2	6
LVR(S) 2-3 - 2-12	10
LVR(S) 2-13 - 2-26	15
LVR(S) 3-2 - 3-29	10
LVR(S) 3-31 - 3-36	15
LVR(S) 4-2	6
LVR(S) 4-3 - 4-11	10
LVR(S) 4-12 - 4-22	15
LVR(S) 5-2 - 5-16	10
LVR(S) 5-18 - 5-29	15
LVR(S) 10-1 - 10-6	8
LVR(S) 10-7 - 10-22	10
LVR(S) 15-1 - 15-3	8
LVR(S) 15-4 - 15-17	10
LVR(S) 20-1 - 20-3	8
LVR(S) 20-4 - 20-17	10
LVR(S) 32-1-1 - 32-4	4
LVR(S) 32-5-2 - 32-10	10
LVR(S) 32-11 - 32-14	15
LVR(S) 45-1-1 - 45-2	4
LVR(S) 45-3-2 - 45-5	10
LVR(S) 45-6-2 - 45-13-2	15
LVR(S) 64-1-1 - 64-2-2	4
LVR(S) 64-2-1 - 64-4-2	10
LVR(S) 64-4-1 - 64-8-1	15
LVR(S) 90-1-1 - 90-1	4
LVR(S) 90-2-2 - 90-3-2	10
LVR(S) 90-3 - 90-6	15
LVR(S) 120-1 - 120-2-1	10
LVR(S) 120-2 - 120-5-1	15
LVR(S) 120-5 - 120-7	20
LVR(S) 150-1-1 - 150-2-2	10
LVR(S) 150-2-1 - 150-4-1	15
LVR(S) 150-4 - 150-6	20
LVR(S) 200-1-D	10
LVR(S) 200-1-C - 200-2-2C	15
LVR(S) 200-2-C - 200-4	20

Model	LVR Max. Operation pressure [bar]		LVS Max. Operation pressure [bar]
	Oval Flange	DIN Flange	
LVR(S) 1	16	25	25
LVR(S) 2	16	25	25
LVR(S) 3	16	25	25
LVR(S) 4	16	25	25
LVR(S) 5	16	25	25
LVR(S) 10		25	25
LVR(S) 15		25	25
LVR(S) 20		25	25
LVR(S) 32-1-1 - 32-7	16		16
LVR(S) 32-8-2 - 32-14	30		30
LVR(S) 45-1-1 - 45-5	16		16
LVR(S) 45-6-2 - 45-11	30		30
LVR(S) 45-12-2 - 45-13-2	33		33
LVR(S) 64-1-1 - 64-5	16		16
LVR(S) 64-6-2 - 64-8-1	30		30
LVR(S) 90-1-1 - 90-4	16		16
LVR(S) 90-5-2 - 90-6	30		30
LVR(S) 120-1 - 120-7	20		20
LVR(S) 150-1-1 - 150-6	20		20
LVR(S) 200-1-D - 200-4	20		20

How to Read The Curve Charts

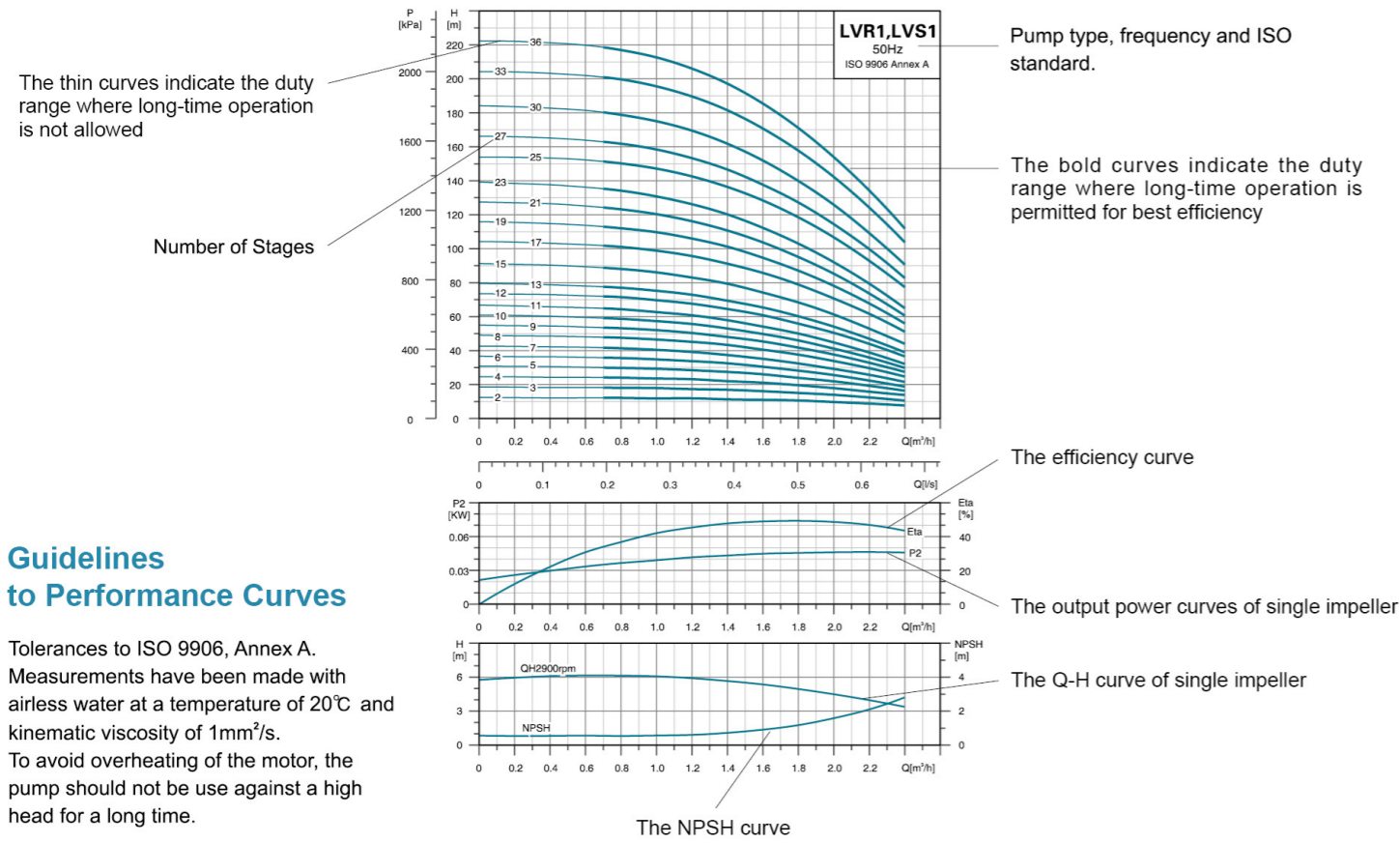

Guidelines to Performance Curves

Tolerances to ISO 9906, Annex A. Measurements have been made with airless water at a temperature of 20°C and kinematic viscosity of 1mm²/s. To avoid overheating of the motor, the pump should not be use against a high head for a long time.

Minimum Flow Rate

Due to the risk of overheating, the pump should not be used at a flow below the minimum flow rate. The curve below shows the minimum flow rate as a percentage of the nominal flow rate in relation to the liquid temperature.

Air cooling apparatus

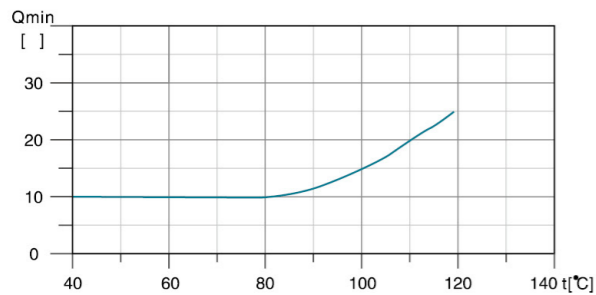

Note: The outlet valve must be opened when the pump is in operation.

Terminal Box Positions

(Note: set to position 1 before delivery)

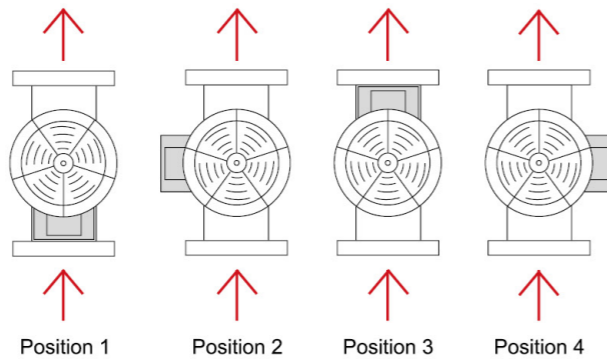

Product Range

MODEL	LVR(S)1	LVR(S)2	LVR(S)3	LVR(S)4	LVR(S)5	LVR(S)10	LVR(S)15	LVR(S)20	LVR(S)32	LVR(S)45	LVR(S)64	LVR(S)90	LVR(S)120	LVR(S)150	LVR(S)200
DESCRIPTION															
Rated flow [m ³ /h]	1	2	3	4	5	10	15	20	32	45	64	90	120	150	200
Flow range [m ³ /h]	0.7-2.4	1.0-3.5	1.2-4.5	1.5-8	2.5-8.5	5-13	8-23	10.5-29	15-40	22-58	30-85	45-120	60-150	80-180	100-240
Max. pressure [bar]	22	23	24	21	24	22	23	25	28	33	22	20	16	16	16
Motor power [kW]	0.37-2.2	0.37-3	0.37-3	0.37-4	0.37-4	1.1-7.5	1.1-15	1.1-18.5	1.5-30	3-45	4-45	5.5-45	11-75	11-75	18.5-110
Temperature Range [°C]	-20°C~+120°C (Note: Both the Max. permissible pressure and liquid temperature range refer to the pump capacity.)														
Max. pump efficiency [%]	45	46	55	59	60	65	70	72	78	79	80	81	74	73	79
Pipe connection-LVR															
Oval flange	G1	G1	G1	G1 1/4	G1 1/4	-	-	-	-	-	-	-	-	-	-
DIN flange	DN25	DN25	DN25	DN32	DN32	DN40	DN50	DN50	DN65	DN80	DN100	DN100	DN125	DN125	DN150
Pipe connection-LVS															
Oval flange	-	-	-	-	-	-	-	-	-	-	-	-	-	-	-
DIN flange	DN32	DN32	DN32	DN32	DN32	DN40	DN50	DN50	DN65	DN80	DN100	DN100	DN125	DN125	DN150
Clamp connector	φ42	φ42	φ42	φ42	φ42	-	-	-	-	-	-	-	-	-	-
Threaded connector	R ₂ 1/4	R ₂ 1/4	R ₂ 1/4	R ₂ 1/4	R ₂ 1/4	-	-	-	-	-	-	-	-	-	-

Scope of Performance-LVR,LVS

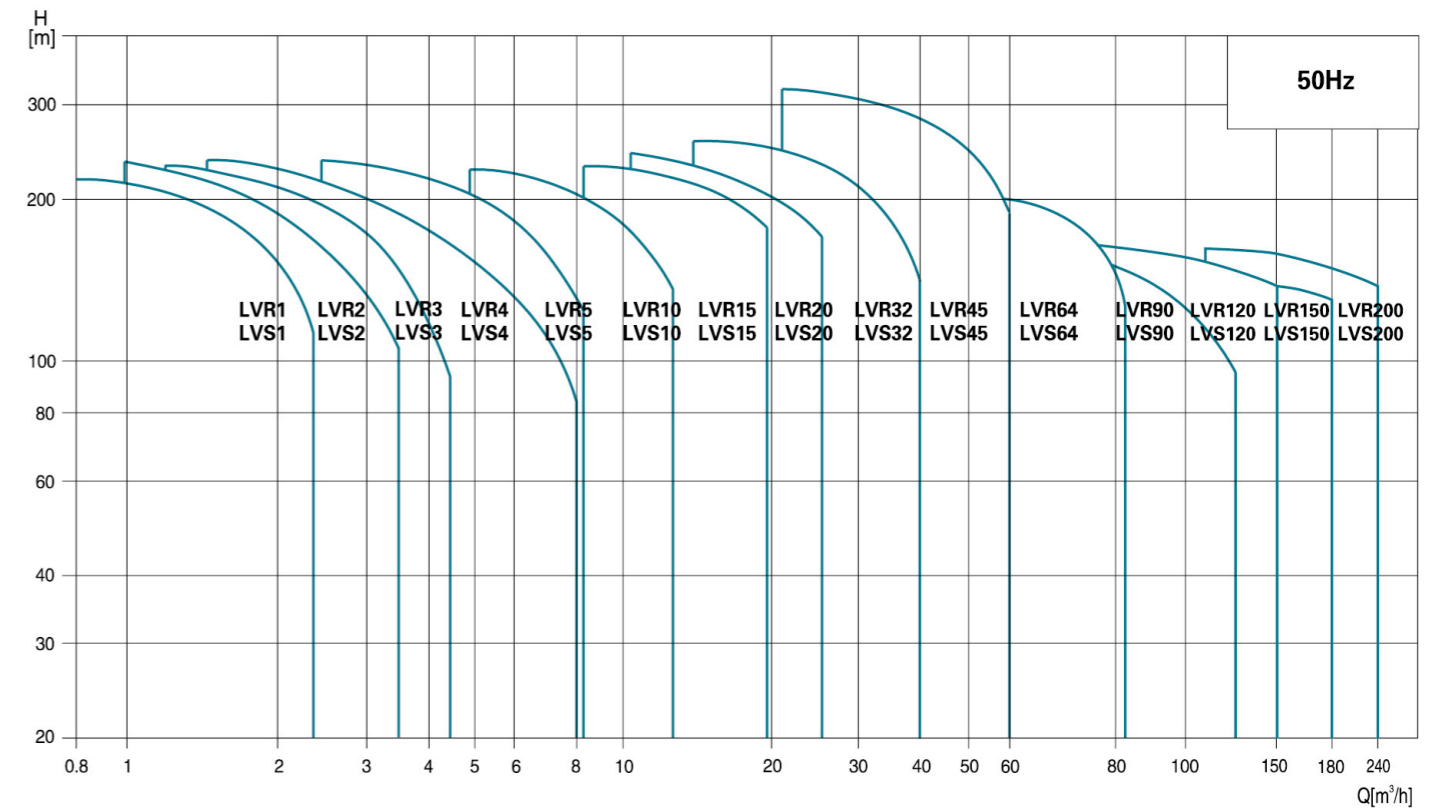

Cross Section

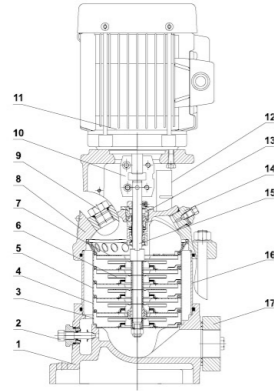

MODEL: LVR1 (2,3,4,5)

Part	Material
1 Base	HT200
2 Drainage plug assembly	AISI304
3 Primary diffuser	AISI304
4 Diffuser with bearing	AISI304
5 Medium diffuser	AISI304
6 Impeller	AISI304
7 Final volute	AISI304
8 Motor base	HT200
9 Filling plug	AISI304
10 Coupling	Iron based powder metallurgy
11 Motor	
12 Guarding plate	AISI304
13 Cartridge seal	
14 Vent plug assembly	AISI304
15 Pump shaft	AISI316
16 Pump barrel	AISI304
17 Oval flange	HT200

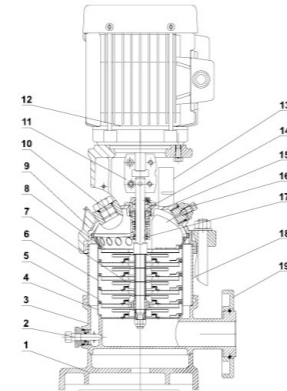

MODEL: LVS1 (2,3,4,5)

Part	Material	Optional Material
1 Base plate	HT200	ZG304
2 Drainage plug assembly	AISI304	AISI316
3 Chasis	ZG304	ZG316
4 Primary diffuser	AISI304	AISI316
5 Diffuser with bearing	AISI304	AISI316
6 Medium diffuser	AISI304	AISI316
7 Impeller	AISI304	AISI316
8 Final volute	AISI304	AISI316
9 Motor base	HT200	
10 Filling plug	AISI304	AISI316
11 Coupling	Iron based powder metallurgy	
12 Motor		
13 Guarding plate	AISI304	
14 Cartridge seal		
15 Pump cover	ZG304	ZG316
16 Vent plug assembly	AISI304	AISI316
17 Pump shaft	AISI316	
18 Pump barrel	AISI304	AISI316
19 Flange	ZG35	

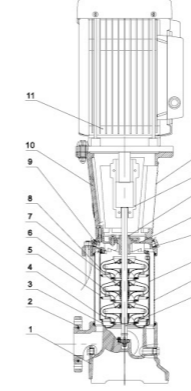

MODEL: LVR32 (45,64,90)

Part	Material
1 Base plate	HT200
2 Flange	ZG35
3 Primary diffuser	AISI304
4 Medium diffuser	AISI304
5 Diffuser with bearing	AISI304
6 Impeller	AISI304
7 Shaft sleeve assembly	
8 Final diffuser	AISI304
9 Vent plug assembly	AISI304
10 Motor base	HT200
11 Motor	
12 Guarding plate	AISI304
13 Coupling	QT400
14 Cartridge seal	
15 HT200 Pump head	HT200
16 Filling plug	AISI304
17 Tension plate	AISI304
18 Pump barrel	AISI304
19 Pump shaft	AISI304

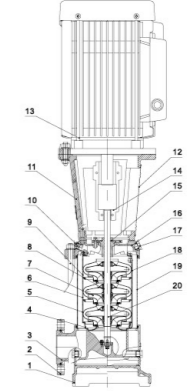

MODEL: LVS32 (45,64,90)

Part	Material	Optional Material
1 Base plate	HT200	ZG304
2 Flange	ZG35	
3 Chasis	ZG304	ZG316
4 Primary diffuser	AISI304	AISI316
5 Medium diffuser	AISI304	AISI316
6 Diffuser with bearing	AISI304	AISI316
7 Impeller	AISI304	AISI316
8 Shaft sleeve assembly		
9 Final diffuser	AISI304	AISI316
10 Vent plug assembly	AISI304	AISI316
11 Motor base	HT200	
12 Motor		
13 Guarding plate	AISI304	
14 Coupling	QT400	
15 Cartridge seal		
16 Pump head	ZG304	ZG316
17 Filling plug	AISI304	AISI316
18 Tension plate	AISI304	AISI316
19 Pump barrel	AISI304	AISI316
20 Pump shaft	AISI304	AISI316

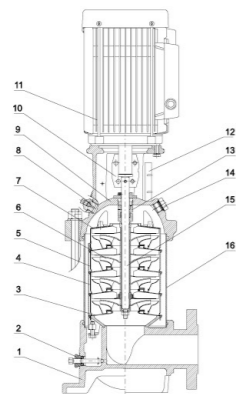

MODEL: LVR10 (15,20)

Part	Material
1 Base	HT200
2 Drainage plug assembly	AISI304
3 Primary diffuser	AISI304
4 Diffuser with bearing	AISI304
5 Medium diffuser	AISI304
6 Impeller	AISI304
7 Final volute	AISI304
8 Filling plug	AISI304
9 Motor base	HT200
10 Coupling	Iron based powder metallurgy
11 Motor	
12 Guarding plate	AISI304
13 Cartridge seal	
14 Vent plug assembly	AISI304
15 Pump shaft	AISI316
16 Pump barrel	AISI304

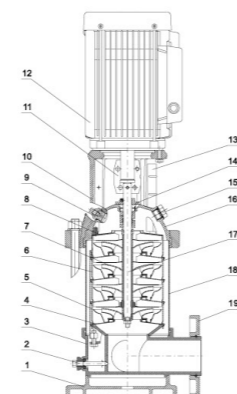

MODEL: LVS10 (15,20)

Part	Material	Optional Material
1 Base plate	HT200	ZG304
2 Drainage plug assembly	AISI304	AISI316
3 Chasis	ZG304	ZG316
4 Primary diffuser	AISI304	AISI316
5 Diffuser with bearing	AISI304	AISI316
6 Medium diffuser	AISI304	AISI316
7 Impeller	AISI304	AISI316
8 Final volute	AISI304	AISI316
9 Filling plug	AISI304	AISI316
10 Motor base	HT200	
11 Coupling	Iron based powder metallurgy	
12 Motor		
13 Guarding plate	AISI304	
14 Cartridge seal		
15 Vent plug assembly	AISI304	AISI316
16 Pump cover	ZG304	AISI316
17 Pump shaft	AISI316	
18 Pump barrel	AISI304	AISI316
19 Flange	ZG35	

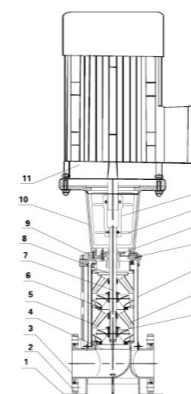

MODEL: LVR120 (150,200)

Part	Material
1 Base plate	HT200
2 Flange	ZG35
3 Base	HT200
4 Primary diffuser	AISI304
5 Medium diffuser	AISI304
6 Diffuser with bearing	AISI304
7 Impeller	AISI304
8 Final diffuser	AISI304
9 Pump head	HT200
10 Motor base	HT200
11 Motor	
12 Coupling	QT400
13 Guarding plate	AISI304
14 Cartridge seal	
15 Filling plug	AISI304
16 Tension plate	AISI304
17 Pump barrel	AISI304
18 Pump shaft	AISI304

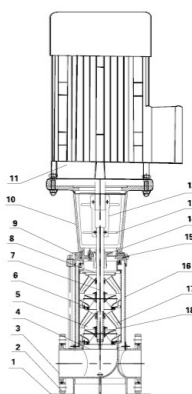

MODEL: LVS120 (150,200)

Part	Material	Optional Material
1 Base plate	HT200	
2 Flange	ZG35	
3 Chasis	ZG304	ZG316
4 Primary diffuser	AISI304	AISI316
5 Medium diffuser	AISI304	AISI316
6 Diffuser with bearing	AISI304	AISI316
7 Impeller	AISI304	AISI316
8 Final diffuser	AISI304	AISI316
9 Pump head	ZG304	ZG316
10 Motor base	HT200	
11 Motor		
12 Coupling	QT400	
13 Guarding plate	AISI304	
14 Cartridge seal		
15 Filling plug	AISI304	AISI316
16 Tension plate	AISI304	AISI316
17 Pump barrel	AISI304	AISI316
18 Pump shaft	AISI304	AISI316

Hydraulic Performance Curves

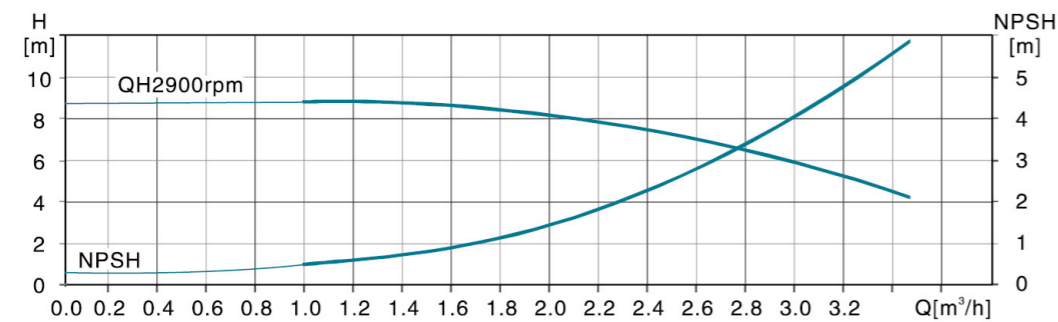
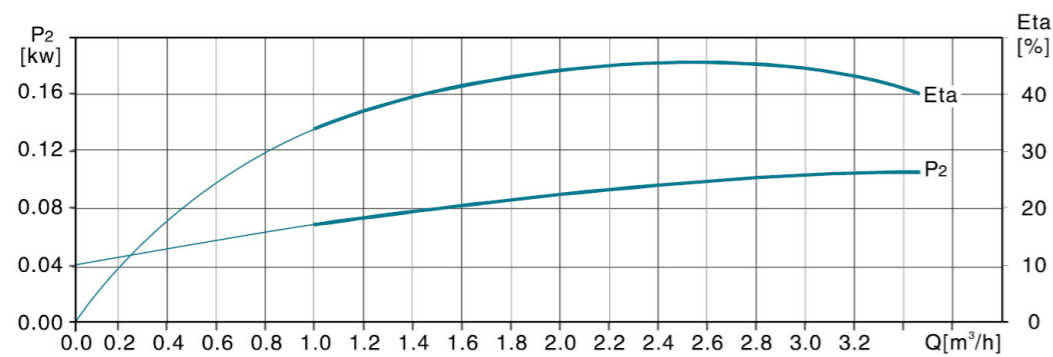
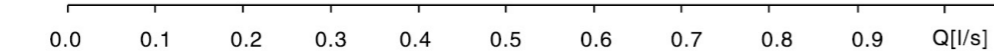
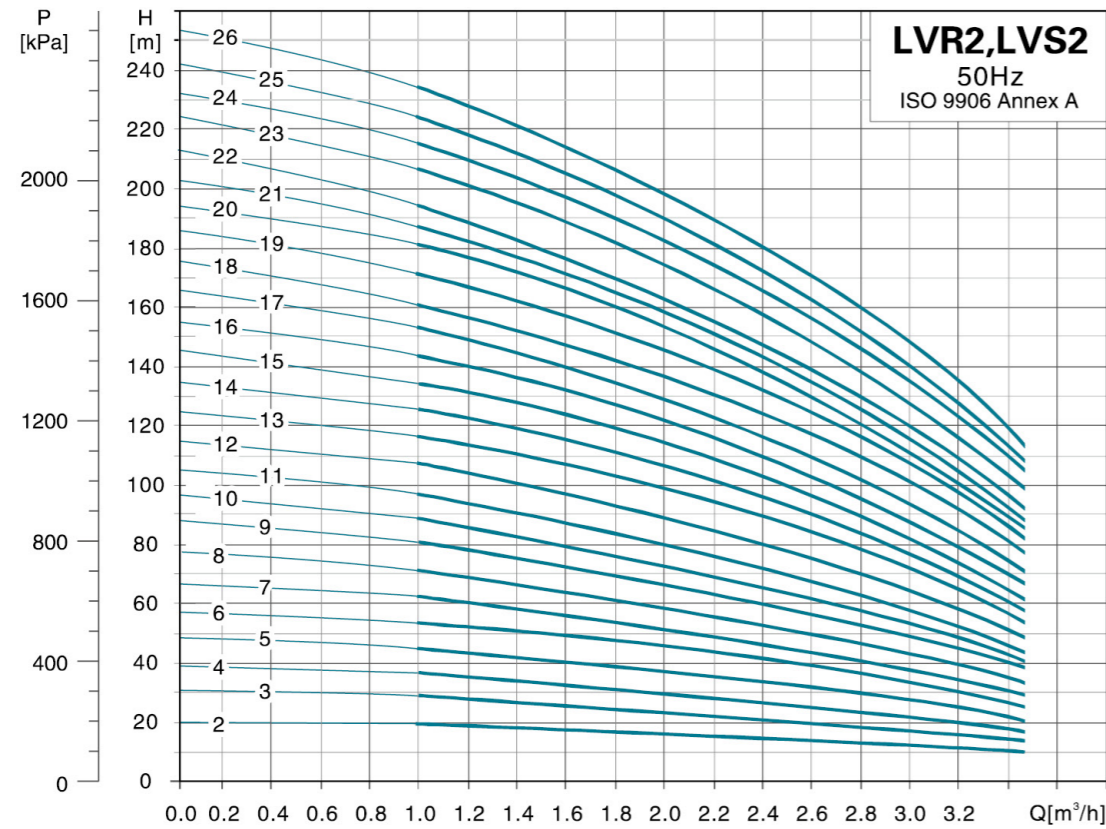

Dimension Drawing

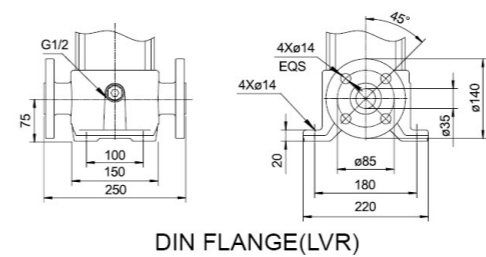
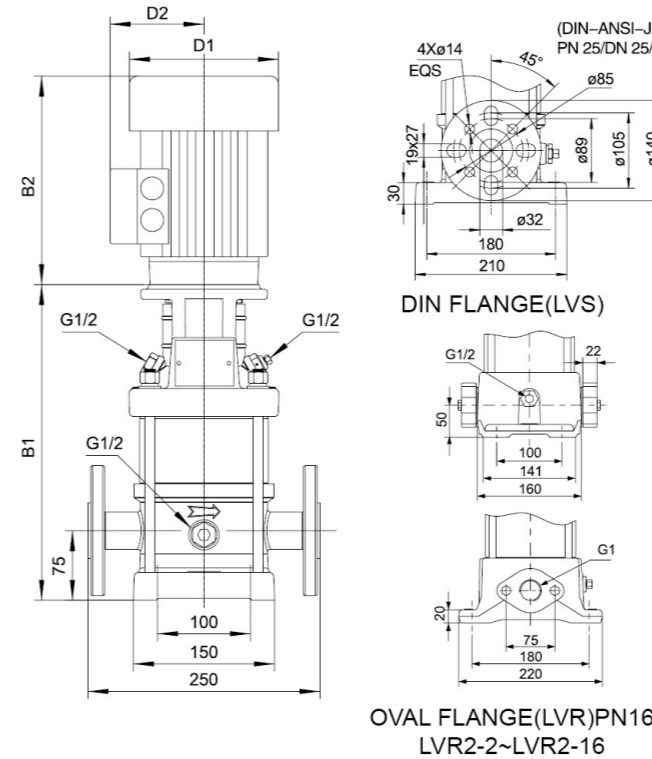

MODEL	OVAL FLANGE (LVR)		DIN FLANGE (LVR, LVS)		D1	D2	N.W. (kgs)
	B1	B1+B2	B1	B1+B2			
2-2	256	470	282	496	130	105	22.3
2-3	256	470	282	496	130	105	22.5
2-4	274	488	300	514	130	105	22.3
2-5	292	506	318	532	130	105	22.8
2-6	314	582	340	608	149.6	124.5	26.6
2-7	332	600	358	626	149.6	124.5	27.1
2-8	350	618	376	644	150	124.5	29.1
2-9	368	636	394	662	150	124.5	29.5
2-10	386	654	412	680	150	124.5	30
2-11	404	672	430	698	150	124.5	30.4
2-12	438	756	464	782	163.6	127	35.9
2-13	456	774	482	800	163.6	127	36.2
2-14	474	792	500	818	163.6	127	37.8
2-15	492	810	518	836	164	127	38.1
2-16	510	828	536	854	164	127	40.9
2-17	528	846	554	872	164	127	40.9
2-18	546	864	572	890	164	127	41
2-19	564	882	590	908	164	127	42.2
2-20	582	900	608	926	164	127	42.7
2-21	600	918	626	944	164	127	43.1
2-22	618	936	644	962	164	127	46.6
2-23	640	980	666	1006	185.5	120	50.4
2-24	658	998	684	1024	185.5	120	50.8
2-25	676	1016	702	1042	185.5	120	51.2
2-26	694	1034	720	1060	185.5	120	51.6

Note: B1 and B1+B2 of clamp connector and threaded connector are in compliance with that of DIN flange.

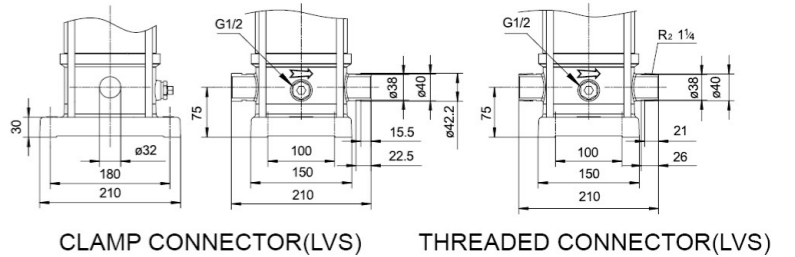

MODEL	POWER[kW]	Q[m³/h]	1.0	1.2	1.6	2.0	2.5	2.8	3.2	3.5
LVR(S)2-2	0.37	18	17	16	15.5	13.5	12	10	8	
LVR(S)2-3	0.37	27	26	24	22.5	19.5	18	15	12	
LVR(S)2-4	0.55	36	35	33	30.5	27	24	17	16	
LVR(S)2-5	0.55	45	43	40	37	32.5	30	24	20	
LVR(S)2-6	0.75	53	52	50	45.5	40	36	30	24	
LVR(S)2-7	0.75	63	61	57	52	45.5	41	35	28	
LVR(S)2-8	1.1	71	69	65	59	51	47	40	33	
LVR(S)2-9	1.1	80	78	73	68.5	60	54	45	37	
LVR(S)2-10	1.1	89	86	81	74	65	59	49	40	
LVR(S)2-11	1.1	98	95	89	82	71.5	64	54	44	
LVR(S)2-12	1.5	107	103	97	90	78	71	59	47	
LVR(S)2-13	1.5	116	114	106	98	86.5	78	65	52	
LVR(S)2-14	1.5	125	122	114	105	92	84	69	57	
LVR(S)2-15	1.5	134	130	123	112	98	90	73	60	
LVR(S)2-16	2.2	143	139	131	120	104	96	79	66	
LVR(S)2-17	2.2	152	148	139	128	111	102	85	70	
LVR(S)2-18	2.2	161	157	148	136	122	108	91	76	
LVR(S)2-19	2.2	170	165	156	143	128	113	95	81	
LVR(S)2-20	2.2	179	174	164	150	134	119	100	85	
LVR(S)2-21	2.2	188	183	172	157	140	124	105	88	
LVR(S)2-22	2.2	197	192	180	165	145	130	110	90	
LVR(S)2-23	3.0	205	201	188	173	153	137	105	97	
LVR(S)2-24	3.0	214	210	197	181	160	144	120	105	
LVR(S)2-25	3.0	223	219	205	189	168	151	125	107	
LVR(S)2-26	3.0	232	228	214	198	176	158	130	110	

Hydraulic Performance Curves

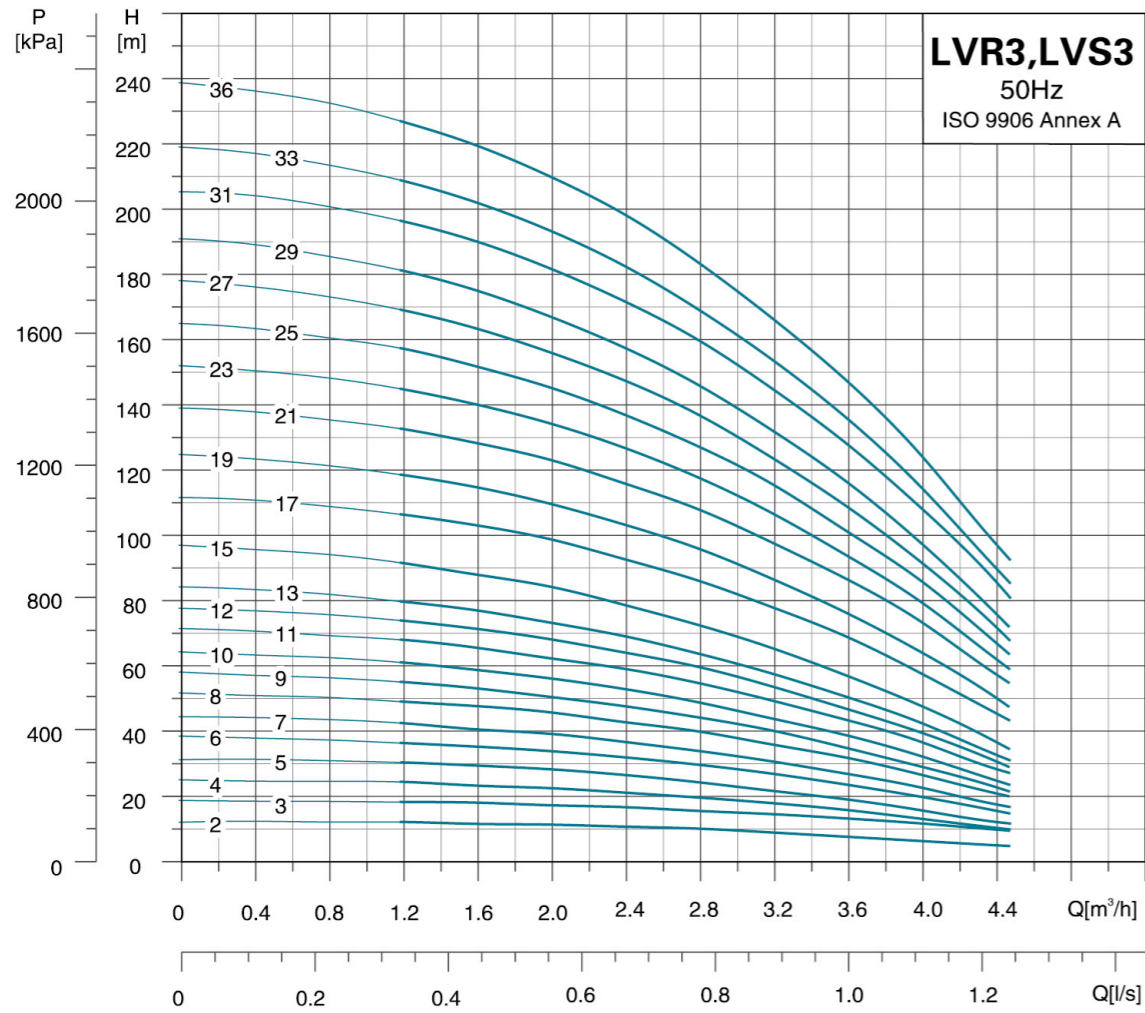

Dimension Drawing

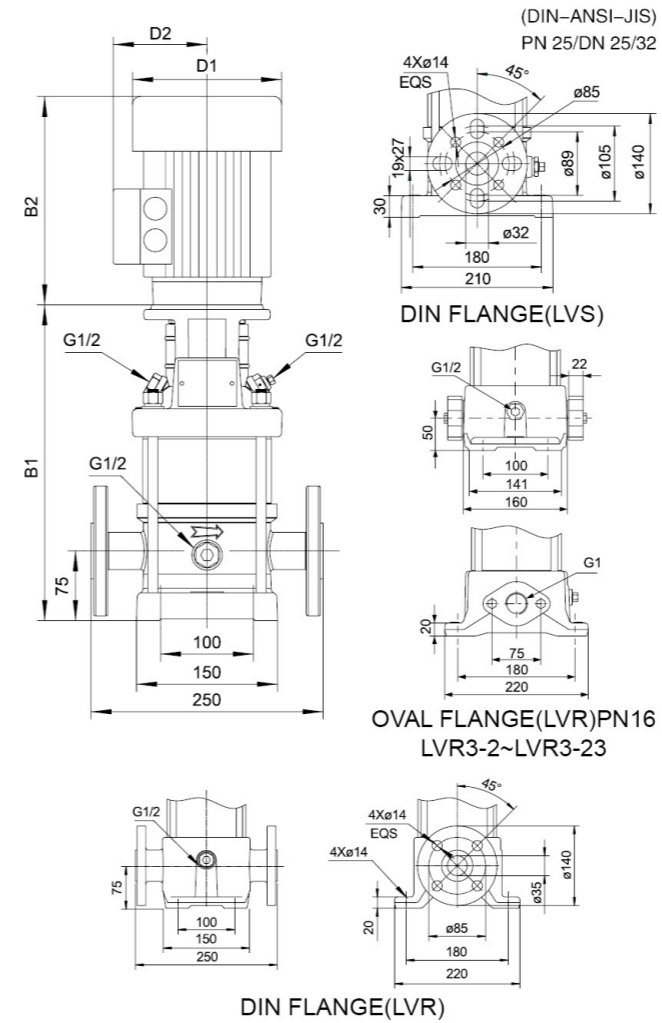

MODEL	OVAL FLANGE (LVR)		DIN FLANGE (LVR, LVS)		D1	D2	N.W. (kgs)
	B1	B1+B2	B1	B1+B2			
3-2	256	470	282	496	130	105	21
3-3	256	470	282	496	130	105	21.4
3-4	274	488	300	514	130	105	21.8
3-5	292	506	318	532	130	105	22.8
3-6	310	524	336	550	130	105	23.3
3-7	328	542	354	568	130	105	23.7
3-8	350	618	376	644	150	124	25.5
3-9	368	636	394	662	150	124	26.6
3-10	386	654	412	680	150	124	27.2
3-11	404	672	430	698	150	124	28.8
3-12	422	690	448	716	150	124	29.7
3-13	440	708	466	734	150	124	30.1
3-15	476	744	502	770	150	124	32.1
3-17	528	846	554	872	164	127	39.2
3-19	564	882	590	908	164	127	40.2
3-21	600	918	626	944	164	127	42.2
3-23	636	954	662	980	164	127	42.4
3-25	672	990	698	1016	164	127	44.4
3-27	708	1026	734	1052	164	127	44.5
3-29	744	1062	770	1088	164	127	45.3
3-31	784	1124	810	1150	186	120	52.3
3-33	820	1160	846	1186	186	120	53.1
3-36	874	1214	900	1240	186	120	54.7

Note: B1 and B1+B2 of clamp connector and threaded connector are in compliance with that of DIN flange.

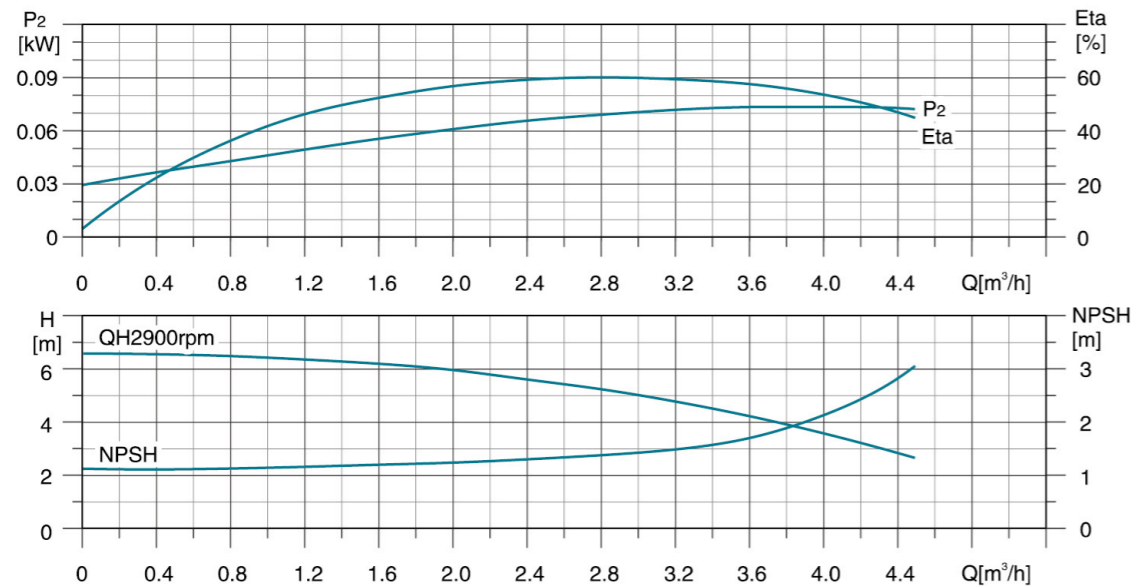
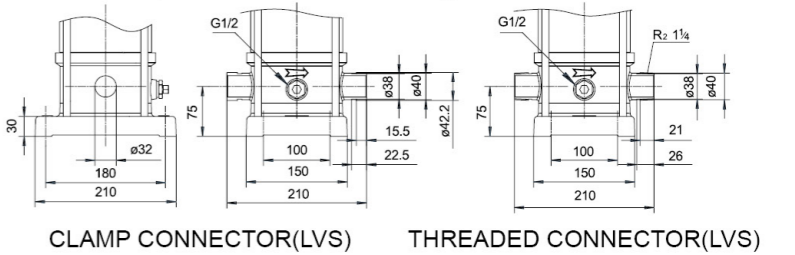

MODEL	POWER[kW]	Q[m³/h]	1.2	1.6	2.0	2.4	2.8	3	3.6	4.0	4.5
LVR(S)3-2	0.37		13	12	12	11	11	10	8	7.5	4
LVR(S)3-3	0.37		19	19	18	17	16	15	14	12	8
LVR(S)3-4	0.37		25	24	23	22	20	19	17	14	9
LVR(S)3-5	0.37		31	31	29	27	25	24	20	17	11
LVR(S)3-6	0.55		37	36	35	33	30	28	24	21	14
LVR(S)3-7	0.55		43	40	40	37	35	32	28	24	16
LVR(S)3-8	0.75		51	48	47	44	41	38	33	28	19
LVR(S)3-9	0.75		56	54	51	48	45	42	36	30	21
LVR(S)3-10	0.75		62	60	57	54	50	46	40	33	23
LVR(S)3-11	1.1		69	66	63	60	56	51	44	38	26
LVR(S)3-12	1.1		75	72	69	65	61	56	48	41	28
LVR(S)3-13	1.1		80	78	74	70	65	60	51	44	30
LVR(S)3-15	1.1		92	89	85	80	73	68	58	49	34
LVR(S)3-17	1.5		107	104	100	94	87	78	70	59	42
LVR(S)3-19	1.5		119	116	111	104	97	87	77	65	47
LVR(S)3-21	2.2		133	129	124	117	109	97	88	75	54
LVR(S)3-23	2.2		146	141	135	128	119	105	95	81	59
LVR(S)3-25	2.2		158	153	146	138	128	115	102	87	64
LVR(S)3-27	2.2		170	164	157	148	138	124	110	93	67
LVR(S)3-29	2.2		182	176	168	159	147	133	118	100	72
LVR(S)3-31	3.0		197	191	183	173	161	142	128	110	80
LVR(S)3-33	3.0		210	203	194	194	170	152	137	116	84
LVR(S)3-36	3.0		228	221	211	200	185	165	149	126	91

Hydraulic Performance Curves

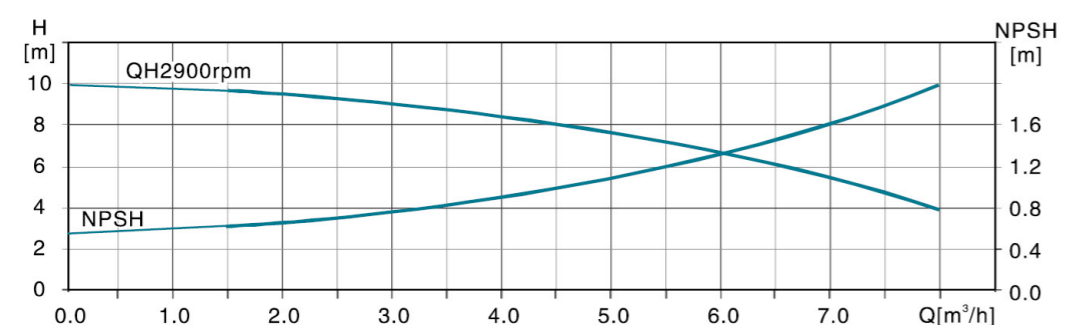
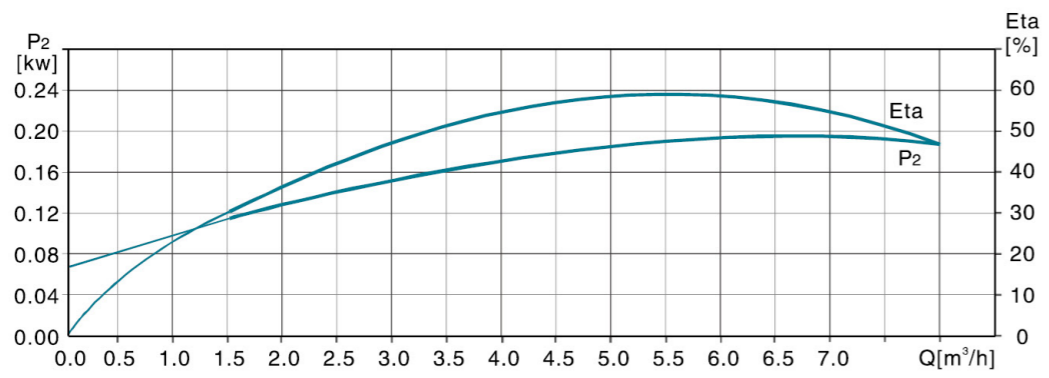
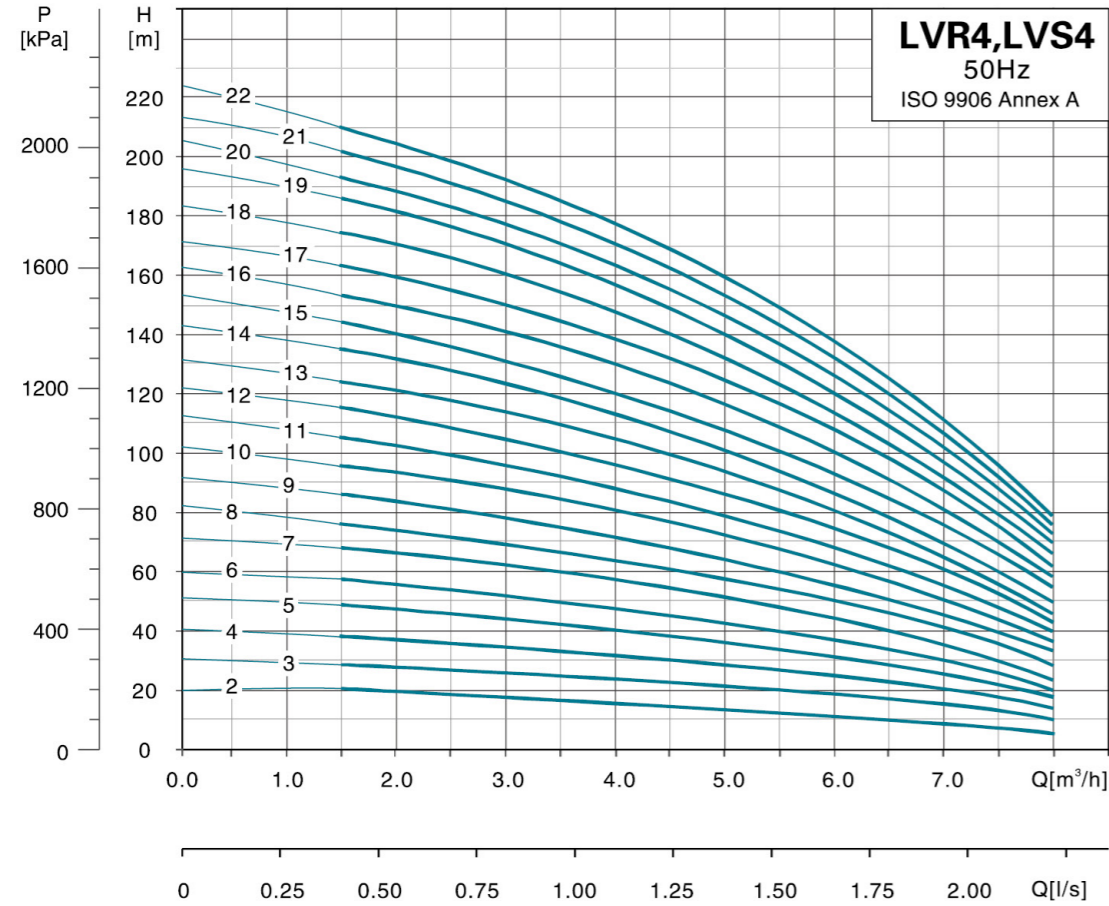

Dimension Drawing

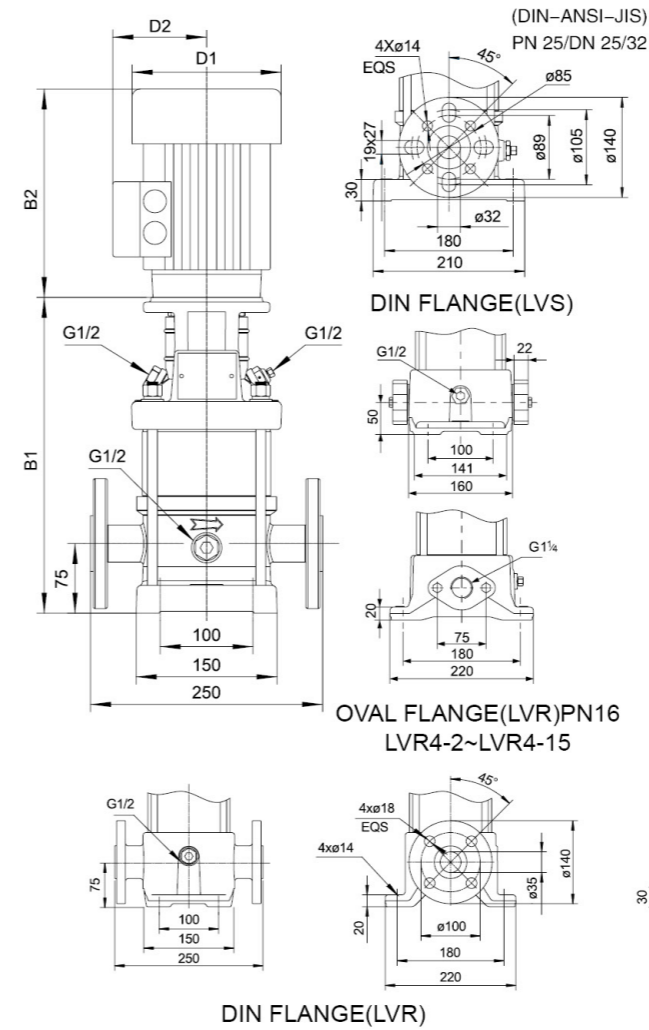

MODEL	OVAL FLANGE (LVR)		DIN FLANGE (LVR, LVS)		D1	D2	N.W. (kgs)
	B1	B1+B2	B1	B1+B2			
4-2	256	470	282	496	130	105	22.4
4-3	283	497	309	523	130	105	23
4-4	314	582	340	608	150	125	25.2
4-5	341	609	367	635	150	125	27.2
4-6	368	636	394	662	150	125	27.4
4-7	411	729	437	755	164	127	34.4
4-8	438	756	464	782	164	127	35.6
4-9	465	783	491	809	164	127	35.9
4-10	492	810	518	836	164	127	36.9
4-11	519	837	545	863	164	127	38.7
4-12	546	864	572	890	164	127	39.8
4-13	577	917	603	943	186	120	47.6
4-14	604	944	630	970	186	120	48.2
4-15	631	971	657	997	186	120	48.8
4-16	658	998	684	1024	186	120	47.3
4-17	685	1025	711	1051	186	120	50.9
4-18	712	1052	738	1078	186	120	53.1
4-19	739	1079	765	1105	186	120	53.4
4-20	766	1106	792	1132	186	120	53.6
4-21	793	1133	819	1159	186	120	53.9
4-22	820	1160	846	1186	186	120	54.2

Note: B1 and B1+B2 of clamp connector and threaded connector are in compliance with that of DIN flange.

MODEL	POWER[kW]	Q[m³/h]	1.5	2.0	3.0	4.0	5.0	6.0	7.0	8.0
LVR(S)4-2	0.37	H(m)	19	18	17	14.5	13	10.5	8	6
LVR(S)4-3	0.55		28	27	26	23.5	20	18	14	10
LVR(S)4-4	0.75		38	36	34	31.5	27	24.5	18	13
LVR(S)4-5	1.1		47	45	43	40.5	34	31.5	23	17
LVR(S)4-6	1.1		56	54	52	47.5	41	36	28	20
LVR(S)4-7	1.5		66	63	61	57	48	44.5	34	24
LVR(S)4-8	1.5		74	72	70	64	55	49.5	38	27
LVR(S)4-9	2.2		86	81	78	72	63	56	44	32
LVR(S)4-10	2.2		96	90	87	81	71	64	50	34
LVR(S)4-11	2.2		105	99	95	88	78	69	53	39
LVR(S)4-12	2.2		114	108	104	96	85	75	57	41
LVR(S)4-13	3.0		123	117	113	103	93	83	63	45
LVR(S)4-14	3.0		136	126	122	114	101	90	69	48
LVR(S)4-15	3.0		142	135	131	120	108	96	73	52
LVR(S)4-16	3.0		152	144	140	129	115	102	78	55
LVR(S)4-17	4.0		163	153	149	137	122	108	83	62
LVR(S)4-18	4.0		175	162	158	145	129	115	89	65
LVR(S)4-19	4.0		183	171	168	155	137	123	95	67
LVR(S)4-20	4.0		192	180	176	161	144	128	99	72
LVR(S)4-21	4.0		203	200	184	169	152	134	103	75
LVR(S)4-22	4.0		211	210	192	177	160	139	108	79

Hydraulic Performance Curves

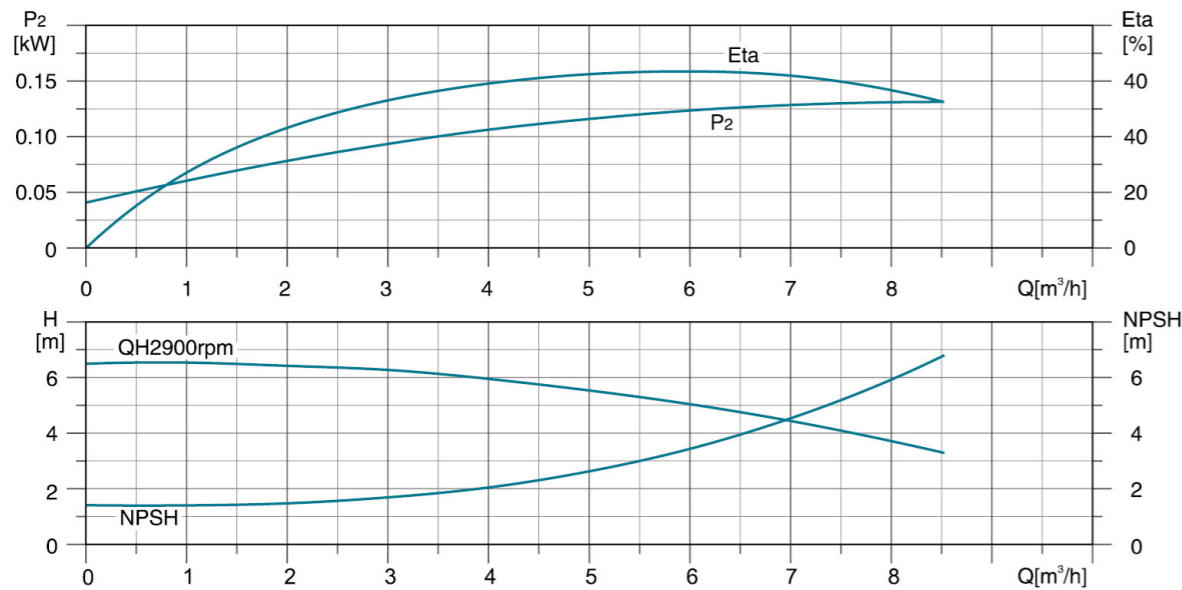
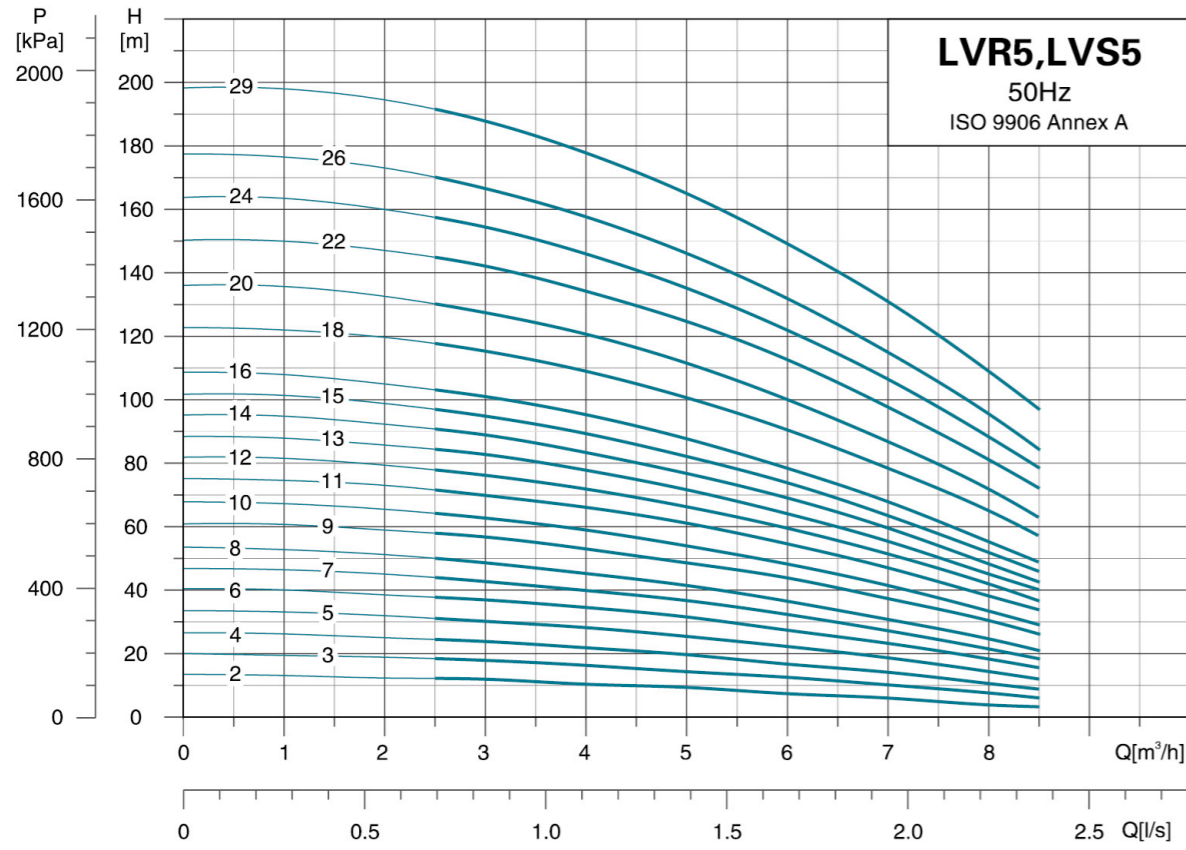

Dimension Drawing

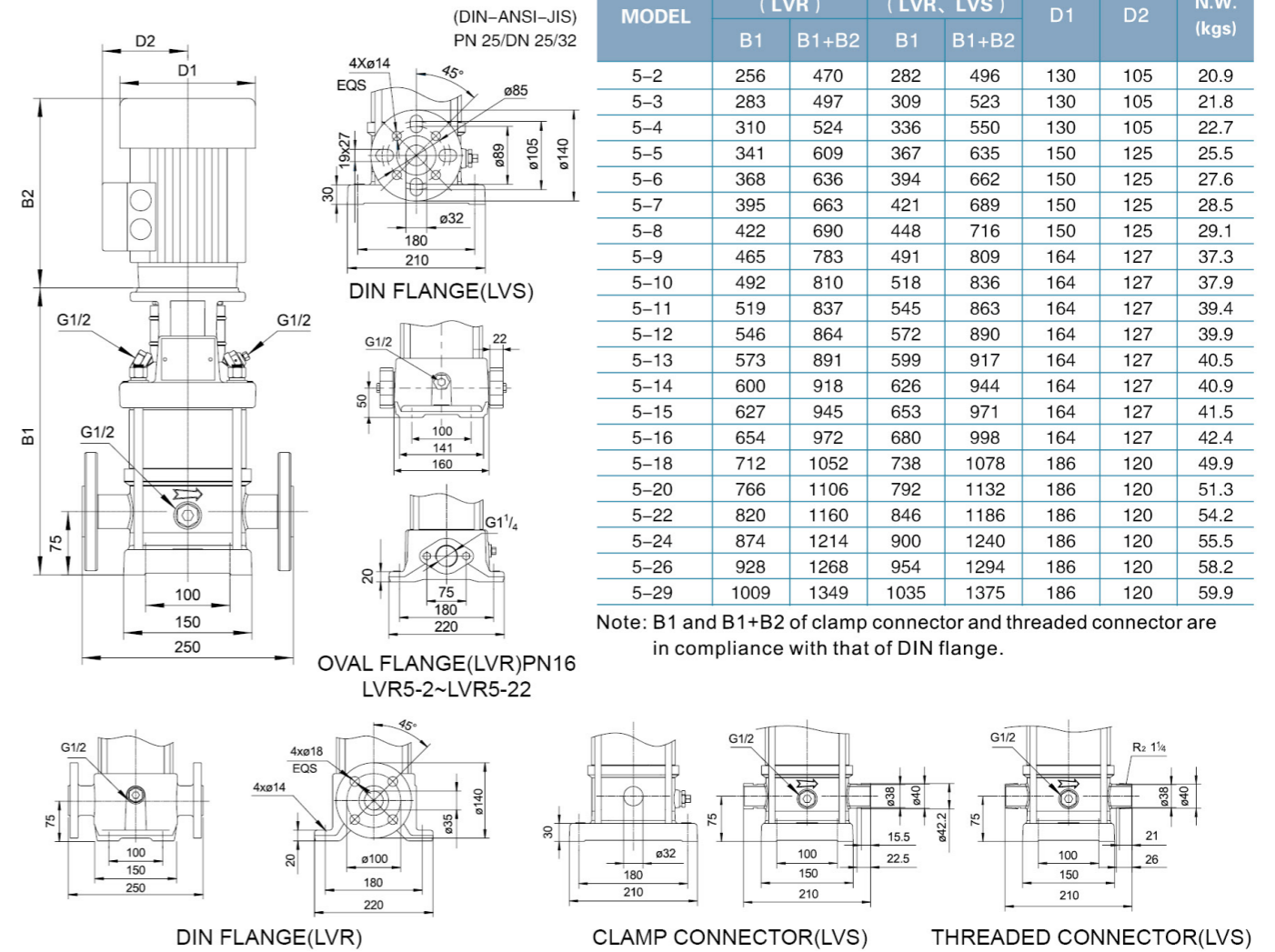

MODEL	OVAL FLANGE (LVR)		DIN FLANGE (LVR, LVS)		D1	D2	N.W. (kgs)
	B1	B1+B2	B1	B1+B2			
5-2	256	470	282	496	130	105	20.9
5-3	283	497	309	523	130	105	21.8
5-4	310	524	336	550	130	105	22.7
5-5	341	609	367	635	150	125	25.5
5-6	368	636	394	662	150	125	27.6
5-7	395	663	421	689	150	125	28.5
5-8	422	690	448	716	150	125	29.1
5-9	465	783	491	809	164	127	37.3
5-10	492	810	518	836	164	127	37.9
5-11	519	837	545	863	164	127	39.4
5-12	546	864	572	890	164	127	39.9
5-13	573	891	599	917	164	127	40.5
5-14	600	918	626	944	164	127	40.9
5-15	627	945	653	971	164	127	41.5
5-16	654	972	680	998	164	127	42.4
5-18	712	1052	738	1078	186	120	49.9
5-20	766	1106	792	1132	186	120	51.3
5-22	820	1160	846	1186	186	120	54.2
5-24	874	1214	900	1240	186	120	55.5
5-26	928	1268	954	1294	186	120	58.2
5-29	1009	1349	1035	1375	186	120	59.9

Note: B1 and B1+B2 of clamp connector and threaded connector are in compliance with that of DIN flange.

MODEL	POWER[kW]	Q[m³/h]	2.5	3.0	4.0	5.0	6.0	7.0	8.0	8.5
LVR(S)5-2	0.37		12	12	10	9	7	6	4	3.5
LVR(S)5-3	0.55		19	18	16	15	12	10	8	6
LVR(S)5-4	0.55		24	24	22	19	16	14	10.5	9
LVR(S)5-5	0.75		31	30	28	24	22	18	15	12
LVR(S)5-6	1.1		38	37	34	28	27	23	19	15
LVR(S)5-7	1.1		44	42	40	32	32	27	22	19
LVR(S)5-8	1.1		50	48	45	40	36	31	25	21
LVR(S)5-9	1.5		59	56	53	47	44	37	31	26
LVR(S)5-10	1.5		65	62	59	53	48	41	34	29
LVR(S)5-11	2.2		73	70	66	59	54	47	38	35
LVR(S)5-12	2.2		78	76	72	63	59	51	42	38
LVR(S)5-13	2.2		85	82	78	68	64	55	45	40
LVR(S)5-14	2.2		91	89	83	74	69	60	58	53
LVR(S)5-15	2.2		98	95	89	79	74	63	52	46
LVR(S)5-16	2.2		103	101	95	85	78	68	55	49
LVR(S)5-18	3		118	115	109	98	90	78	65	58
LVR(S)5-20	3		130	127	120	108	100	87	72	64
LVR(S)5-22	4		145	142	134	120	112	97	80	72
LVR(S)5-24	4		158	154	146	132	122	106	88	78
LVR(S)5-26	4		170	166	157	145	132	115	95	85
LVR(S)5-29	4		192	188	178	155	149	131	109	98

Hydraulic Performance Curves

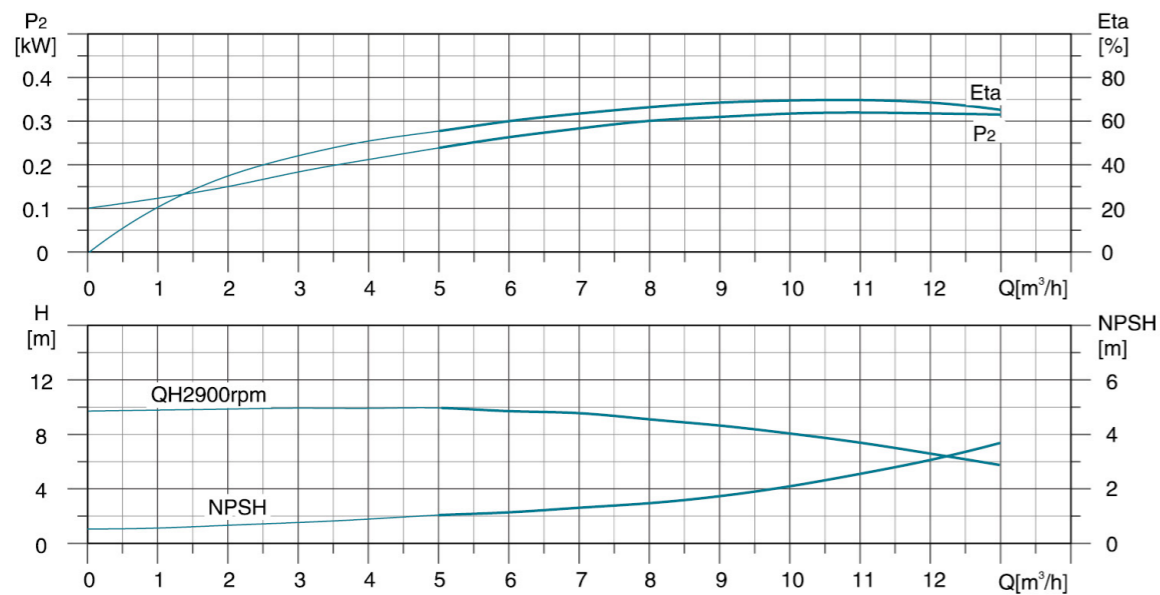
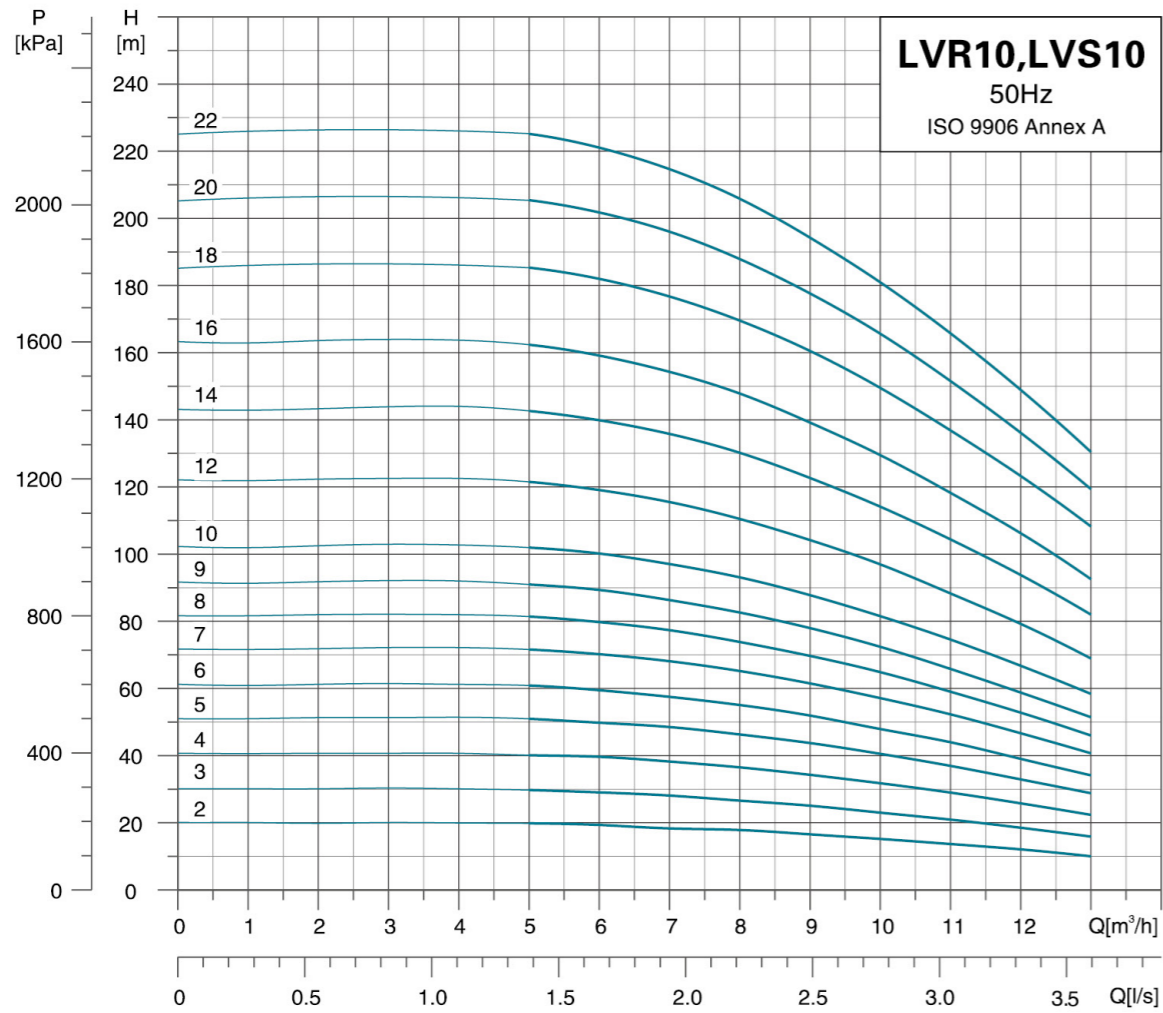

Dimension Drawing

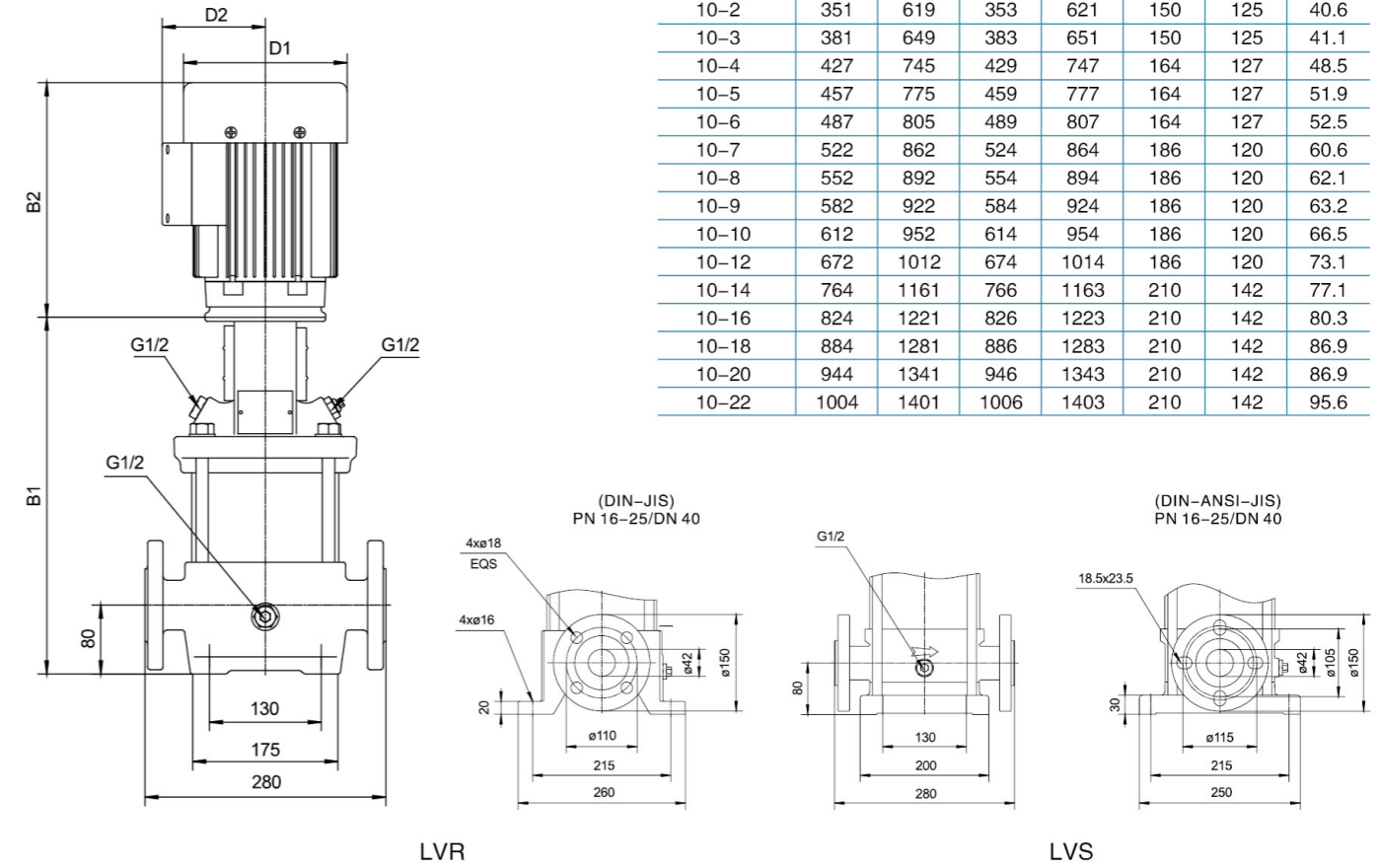

MODEL	DIN FLANGE (LVR)		DIN FLANGE (LVS)		D1	D2	N.W. (kgs)
	B1	B1+B2	B1	B1+B2			
10-2	351	619	353	621	150	125	40.6
10-3	381	649	383	651	150	125	41.1
10-4	427	745	429	747	164	127	48.5
10-5	457	775	459	777	164	127	51.9
10-6	487	805	489	807	164	127	52.5
10-7	522	862	524	864	186	120	60.6
10-8	552	892	554	894	186	120	62.1
10-9	582	922	584	924	186	120	63.2
10-10	612	952	614	954	186	120	66.5
10-12	672	1012	674	1014	186	120	73.1
10-14	764	1161	766	1163	210	142	77.1
10-16	824	1221	826	1223	210	142	80.3
10-18	884	1281	886	1283	210	142	86.9
10-20	944	1341	946	1343	210	142	86.9
10-22	1004	1401	1006	1403	210	142	95.6

MODEL	POWER[kW]	Q[m³/h]	5.0	6.0	8.0	10	12	13
LVR(S)10-2	0.75	H(m)	20	19	18	15	12	10
LVR(S)10-3	1.1		30	29	26	23	18	16
LVR(S)10-4	1.5		40	40	36	32	26	23
LVR(S)10-5	2.2		51	50	46	40	33	29
LVR(S)10-6	2.2		61	59	55	48	39	35
LVR(S)10-7	3		72	70	65	56	46	41
LVR(S)10-8	3		82	80	74	64	53	46
LVR(S)10-9	3		92	89	82	70	59	52
LVR(S)10-10	4		102	100	93	80	66	59
LVR(S)10-12	4		122	119	110	95	79	69
LVR(S)10-14	5.5		142	140	130	113	94	82
LVR(S)10-16	5.5		162	159	148	128	106	93
LVR(S)10-18	7.5		185	182	169	147	123	109
LVR(S)10-20	7.5		206	201	188	164	136	119
LVR(S)10-22	7.5	226	221	206	178	147	130	

Hydraulic Performance Curves

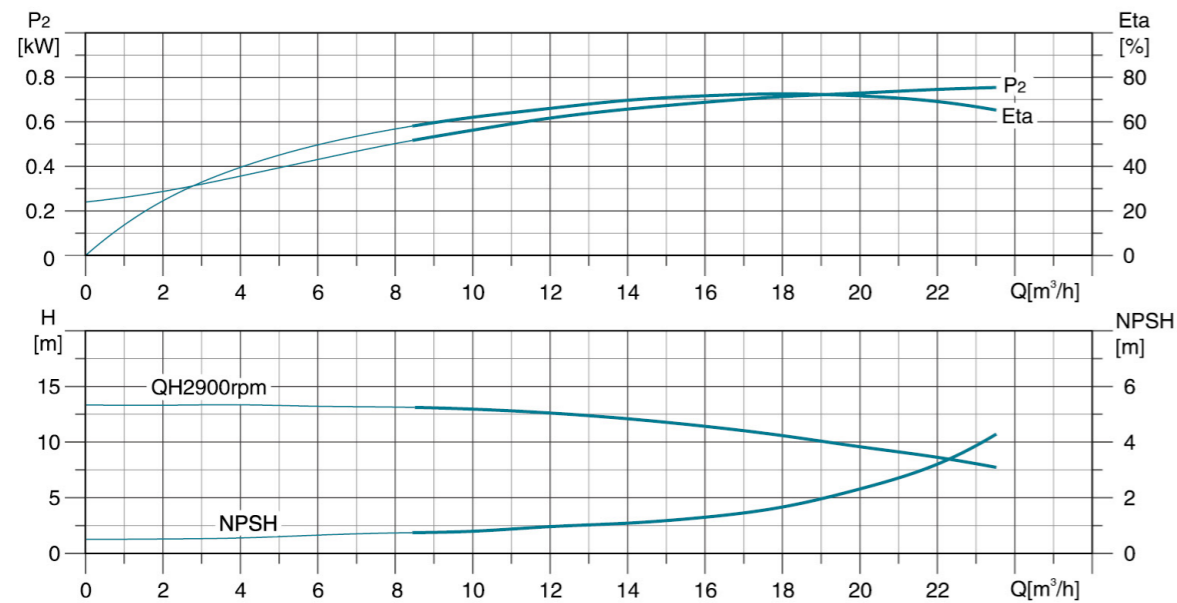
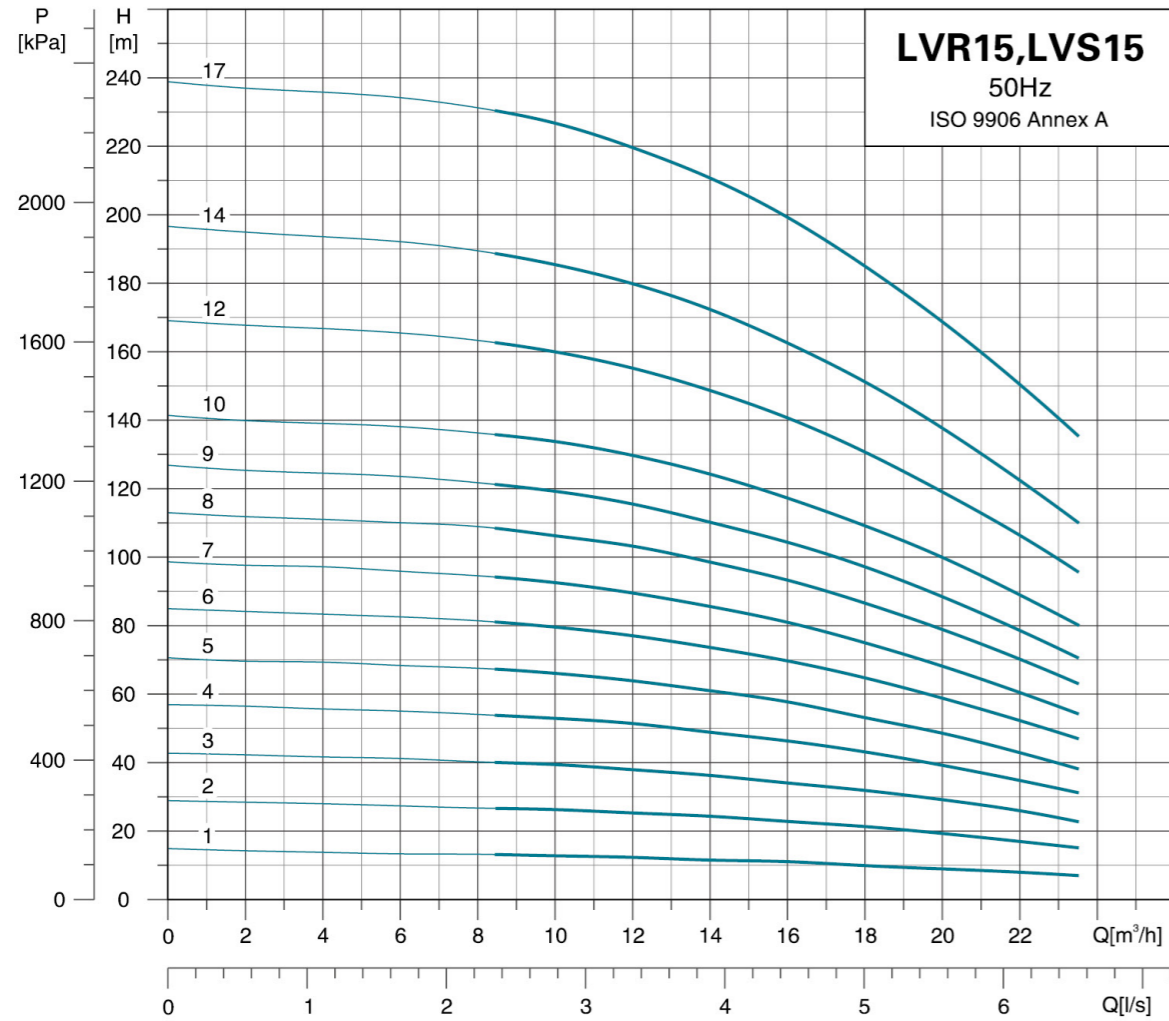

Dimension Drawing

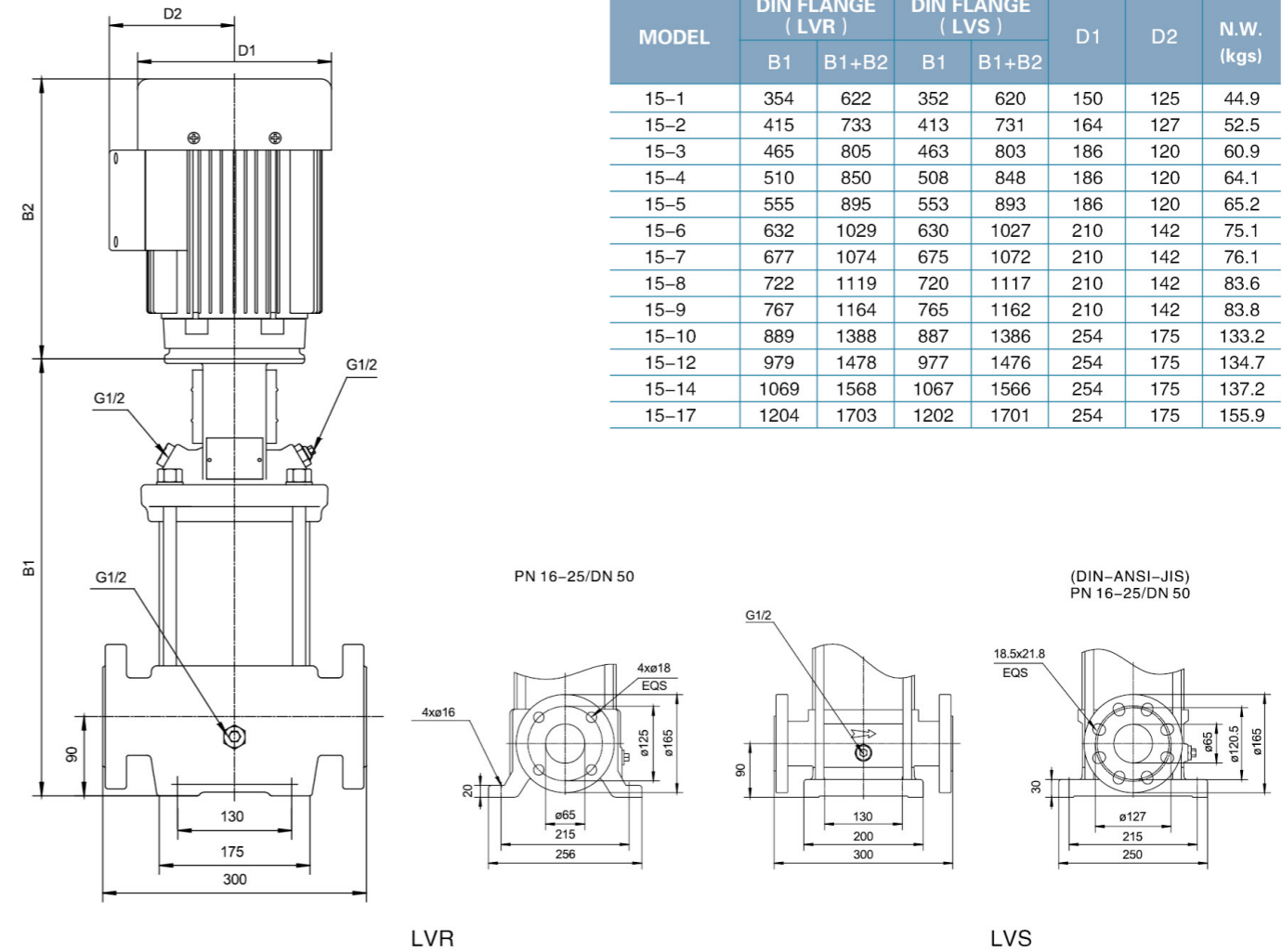

MODEL	DIN FLANGE (LVR)		DIN FLANGE (LVS)		D1	D2	N.W. (kgs)
	B1	B1+B2	B1	B1+B2			
15-1	354	622	352	620	150	125	44.9
15-2	415	733	413	731	164	127	52.5
15-3	465	805	463	803	186	120	60.9
15-4	510	850	508	848	186	120	64.1
15-5	555	895	553	893	186	120	65.2
15-6	632	1029	630	1027	210	142	75.1
15-7	677	1074	675	1072	210	142	76.1
15-8	722	1119	720	1117	210	142	83.6
15-9	767	1164	765	1162	210	142	83.8
15-10	889	1388	887	1386	254	175	133.2
15-12	979	1478	977	1476	254	175	134.7
15-14	1069	1568	1067	1566	254	175	137.2
15-17	1204	1703	1202	1701	254	175	155.9

MODEL	POWER[kW]	Q[m³/h]	8.5	12	15	18	21	23.5
LVR(S)15-1	1.1		13	12	11	10	9	7
LVR(S)15-2	2.2		26	25	23	21	18	15
LVR(S)15-3	3		40	38	35	32	28	22
LVR(S)15-4	4		55	51	47	43	38	32
LVR(S)15-5	4		68	64	58	53	48	38
LVR(S)15-6	5.5		81	77	71	64	58	47
LVR(S)15-7	5.5		95	89	83	75	65	52
LVR(S)15-8	7.5		108	103	96	86	75	62
LVR(S)15-9	7.5		121	115	108	97	84	70
LVR(S)15-10	11		136	129	120	109	95	80
LVR(S)15-12	11		164	155	142	130	114	95
LVR(S)15-14	11		189	180	166	151	130	110
LVR(S)15-17	15		231	219	205	185	160	135

Hydraulic Performance Curves

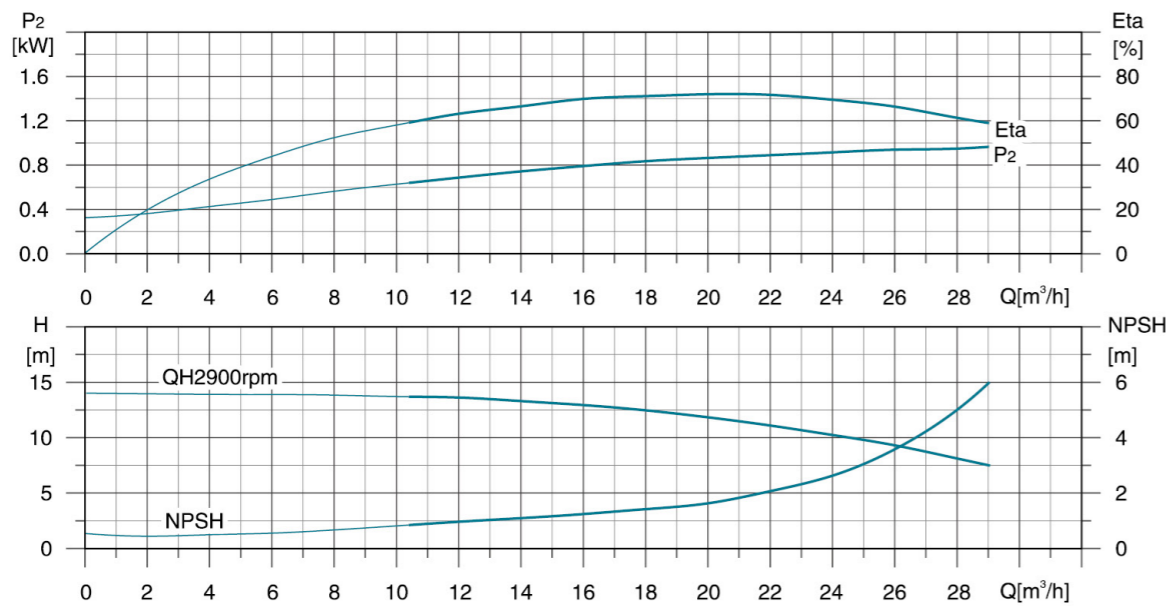
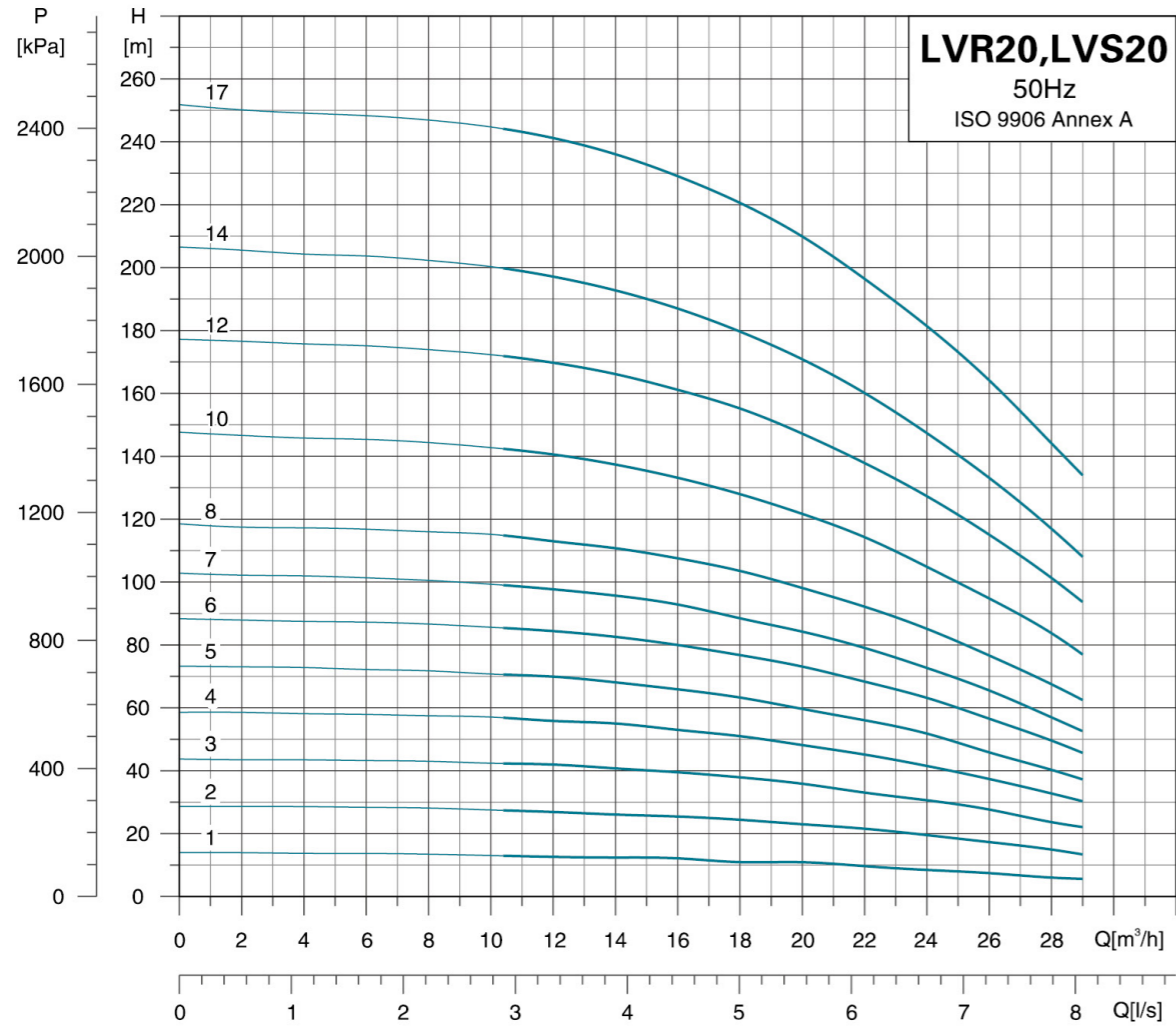

Dimension Drawing

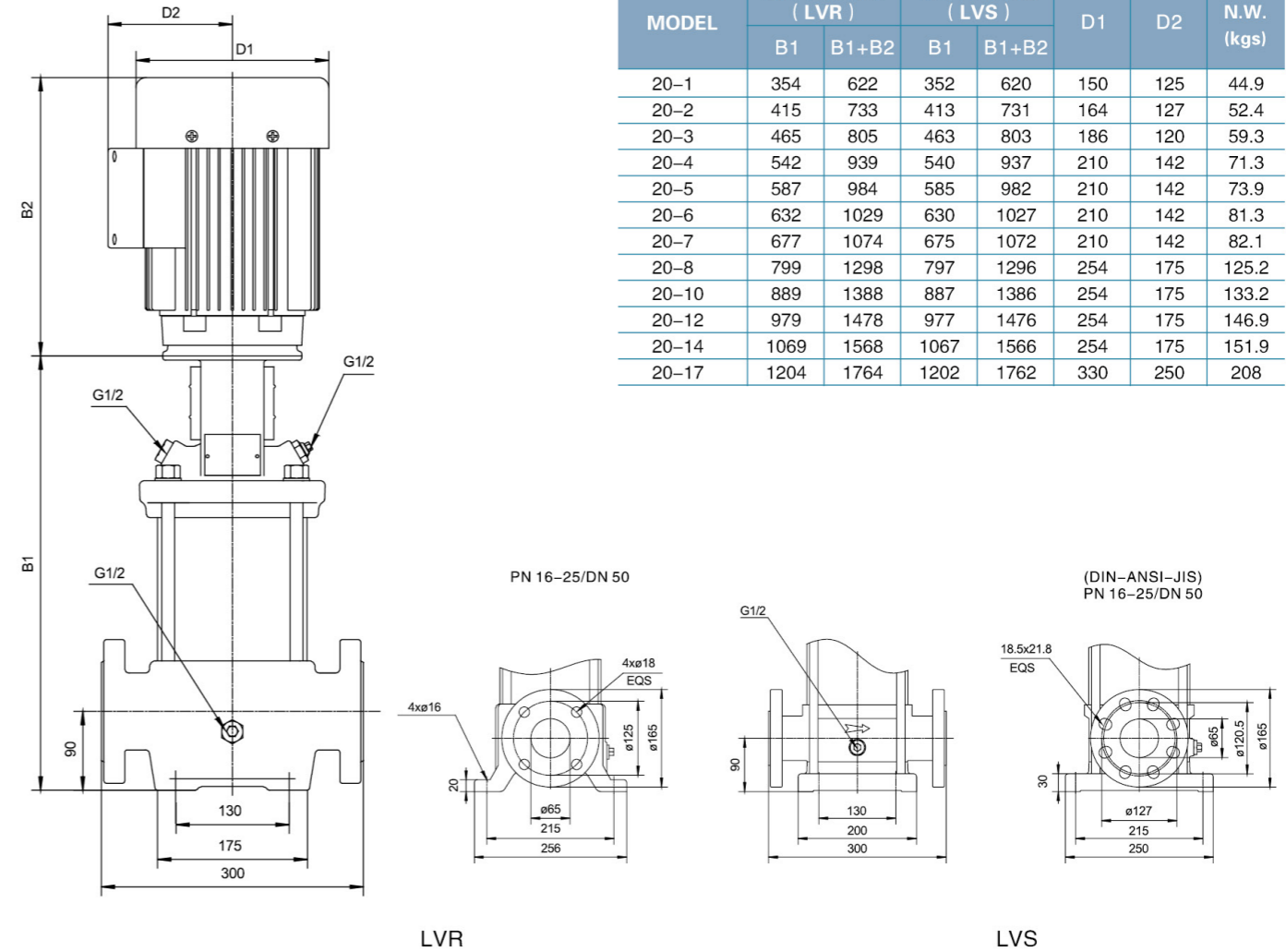

MODEL	DIN FLANGE (LVR)		DIN FLANGE (LVS)		D1	D2	N.W. (kgs)
	B1	B1+B2	B1	B1+B2			
20-1	354	622	352	620	150	125	44.9
20-2	415	733	413	731	164	127	52.4
20-3	465	805	463	803	186	120	59.3
20-4	542	939	540	937	210	142	71.3
20-5	587	984	585	982	210	142	73.9
20-6	632	1029	630	1027	210	142	81.3
20-7	677	1074	675	1072	210	142	82.1
20-8	799	1298	797	1296	254	175	125.2
20-10	889	1388	887	1386	254	175	133.2
20-12	979	1478	977	1476	254	175	146.9
20-14	1069	1568	1067	1566	254	175	151.9
20-17	1204	1764	1202	1762	330	250	208

MODEL	POWER[kW]	Q[m³/h]	10.5	12	16	20	24	28	28.5
LVR(S)20-1	1.1	H(m)	13	13	12	10.5	9	6.5	6
LVR(S)20-2	2.2		28	27	25	22.5	19	15	13
LVR(S)20-3	4		42	42	39	36	30	23	22
LVR(S)20-4	5.5		58	56	53	48	41	32	30
LVR(S)20-5	5.5		71	70	66	60	52	40	38
LVR(S)20-6	7.5		86	84	80	72	62	49	45
LVR(S)20-7	7.5		99	97	93	84	72	57	52
LVR(S)20-8	11		115	113	107	96	85	67	63
LVR(S)20-10	11		142	140	132	120	105	83	78
LVR(S)20-12	15		172	169	161	144	127	101	94
LVR(S)20-14	15		200	197	187	168	147	117	109
LVR(S)20-17	18.5		245	241	229	205	181	144	135

Hydraulic Performance Curves

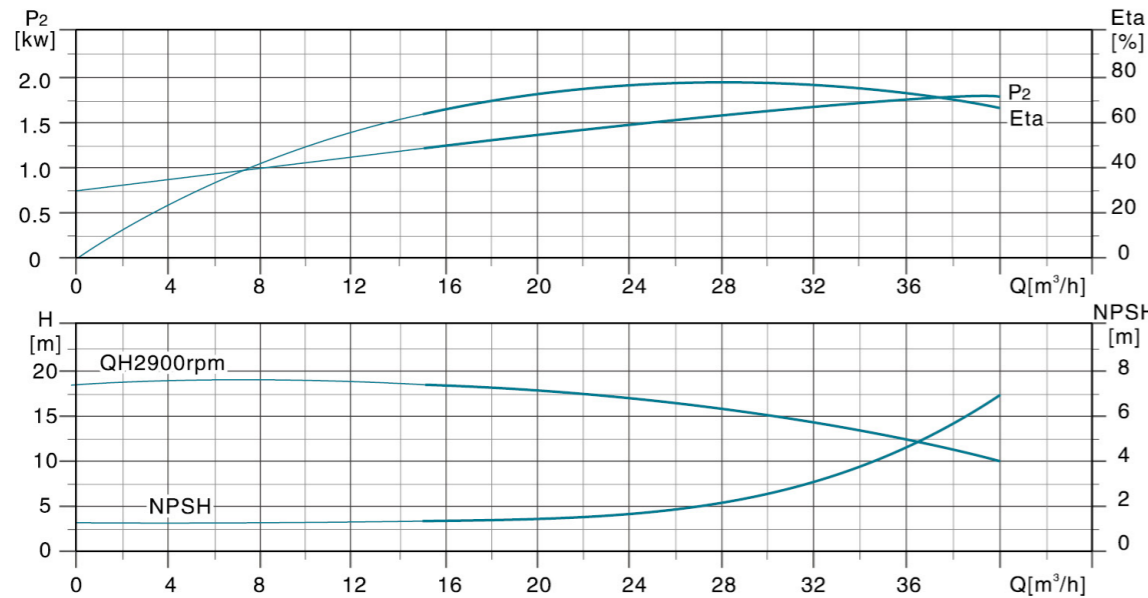
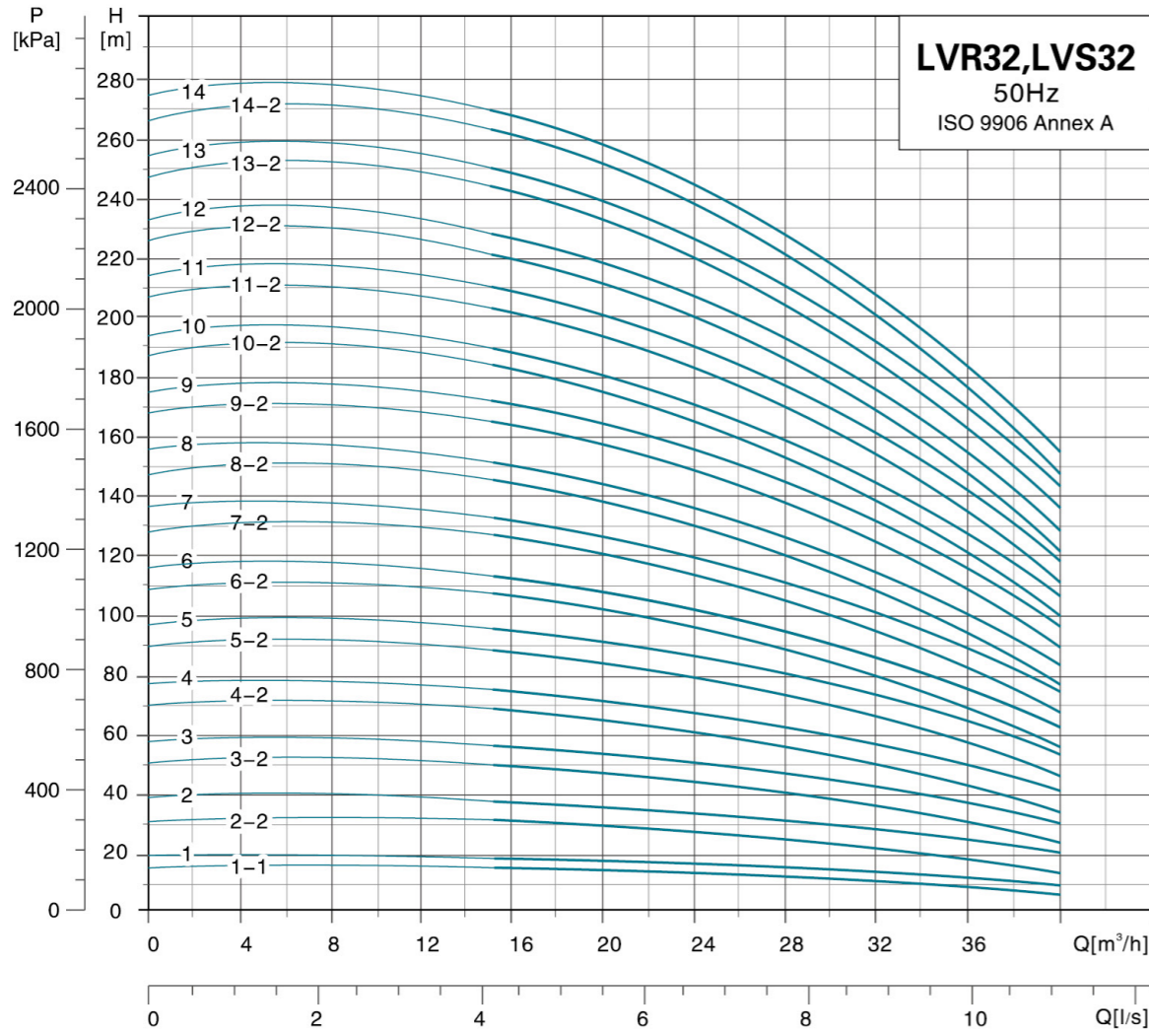

Dimension Drawing

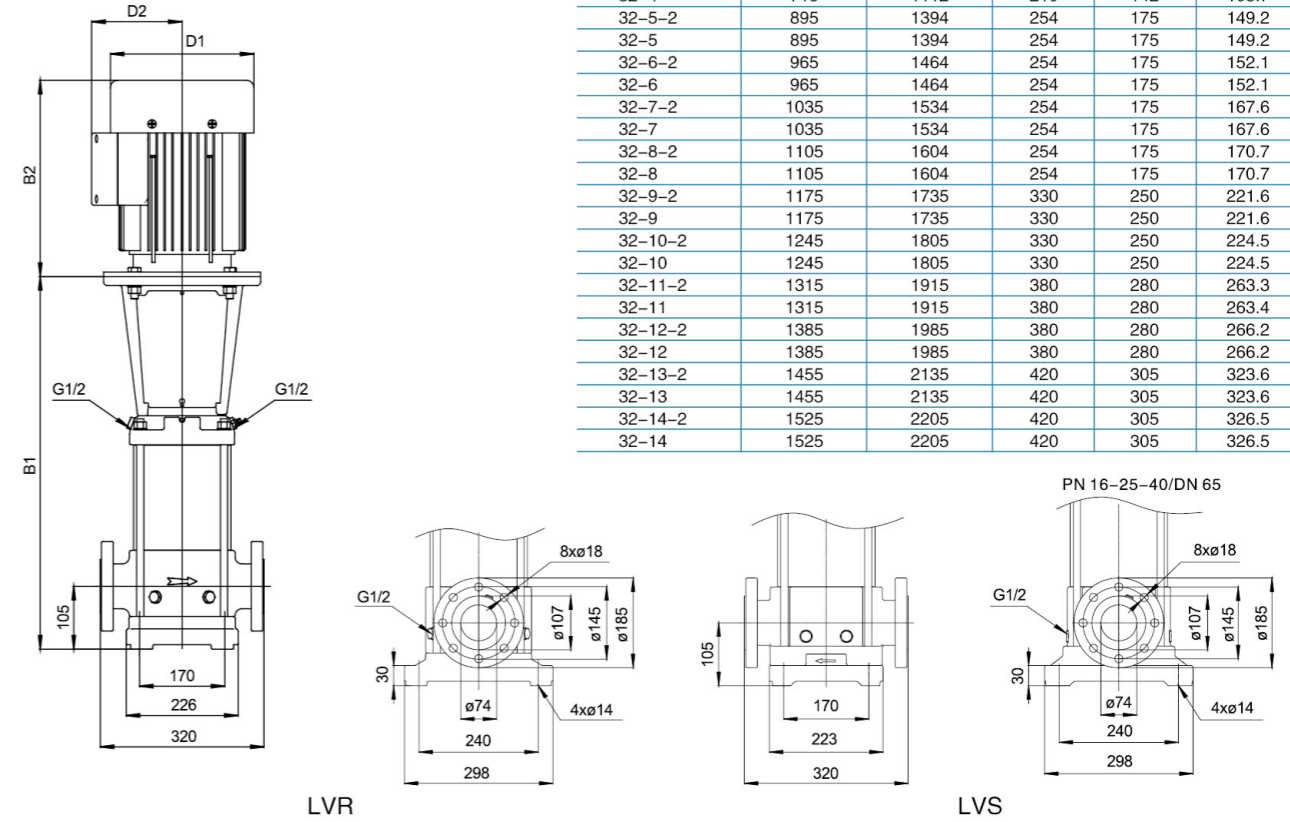

MODEL	DIN FLANGE(LVR, LVS)		D1	D2	N.W. (kgs)
	B1	B1+B2			
32-1-1	455	773	164	127	61.7
32-1	455	773	164	127	63.7
32-2-2	525	865	186	120	72.6
32-2	525	865	186	120	74.9
32-3-2	645	1042	210	142	100.9
32-3	645	1042	210	142	100.6
32-4-2	715	1112	210	142	108.7
32-4	715	1112	210	142	108.7
32-5-2	895	1394	254	175	149.2
32-5	895	1394	254	175	149.2
32-6-2	965	1464	254	175	152.1
32-6	965	1464	254	175	152.1
32-7-2	1035	1534	254	175	167.6
32-7	1035	1534	254	175	167.6
32-8-2	1105	1604	254	175	170.7
32-8	1105	1604	254	175	170.7
32-9-2	1175	1735	330	250	221.6
32-9	1175	1735	330	250	221.6
32-10-2	1245	1805	330	250	224.5
32-10	1245	1805	330	250	224.5
32-11-2	1315	1915	380	280	263.3
32-11	1315	1915	380	280	263.4
32-12-2	1385	1985	380	280	266.2
32-12	1385	1985	380	280	266.2
32-13-2	1455	2135	420	305	323.6
32-13	1455	2135	420	305	323.6
32-14-2	1525	2205	420	305	326.5
32-14	1525	2205	420	305	326.5

MODEL	POWER[kW]	Q[m³/h]	15	20	25	32	35	40
LVR(S)32-1-1	1.5		15	14	13	10	8	5
LVR(S)32-1	2.2		18	17	16	13	11.5	9
LVR(S)32-2-2	3		31	29.5	26.5	20.5	17.5	12
LVR(S)32-2	4		37	35.5	32.5	27.5	25	19.5
LVR(S)32-3-2	5.5		50	47	43.5	35.5	31	22.5
LVR(S)32-3	5.5		55.5	53	49	41.5	37.5	29.5
LVR(S)32-4-2	7.5		68.5	65	60	49.5	44	32.5
LVR(S)32-4	7.5		74.5	70.5	66	56	50.5	40
LVR(S)32-5-2	11		88.5	84.5	78	65.5	58.5	45
LVR(S)32-5	11		94.5	90	84	72	65	52
LVR(S)32-6-2	11		107	102	94.5	79.5	71	55
LVR(S)32-6	11		113	108	100	85.5	77.5	61.5
LVR(S)32-7-2	15		127	121	112	94.5	85	66.5
LVR(S)32-7	15		133	126	118	101	92	73.5
LVR(S)32-8-2	15		145	138	128	108	98	76.5
LVR(S)32-8	15		151	144	134	115	104	83
LVR(S)32-9-2	18.5		165	158	147	124	112	88.5
LVR(S)32-9	18.5		171	163	152	131	119	95.5
LVR(S)32-10-2	18.5		184	175	163	138	125	98.5
LVR(S)32-10	18.5		190	181	169	145	133	106
LVR(S)32-11-2	22		203	194	181	154	140	111
LVR(S)32-11	22		209	200	187	161	147	118
LVR(S)32-12-2	22		222	212	197	168	152	121
LVR(S)32-12	22		227	217	203	176	160	128
LVR(S)32-13-2	30		244	233	218	187	169	136
LVR(S)32-13	30		250	239	224	193	177	145
LVR(S)32-14-2	30		263	251	234	201	183	146
LVR(S)32-14	30		269	258	241	207	188	156

Hydraulic Performance Curves

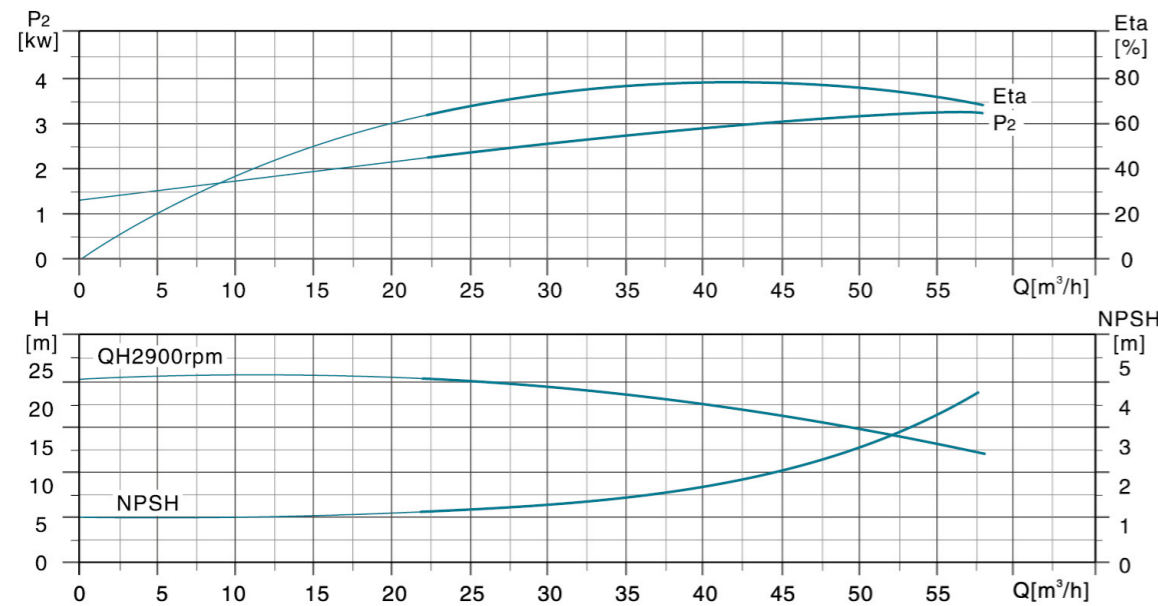
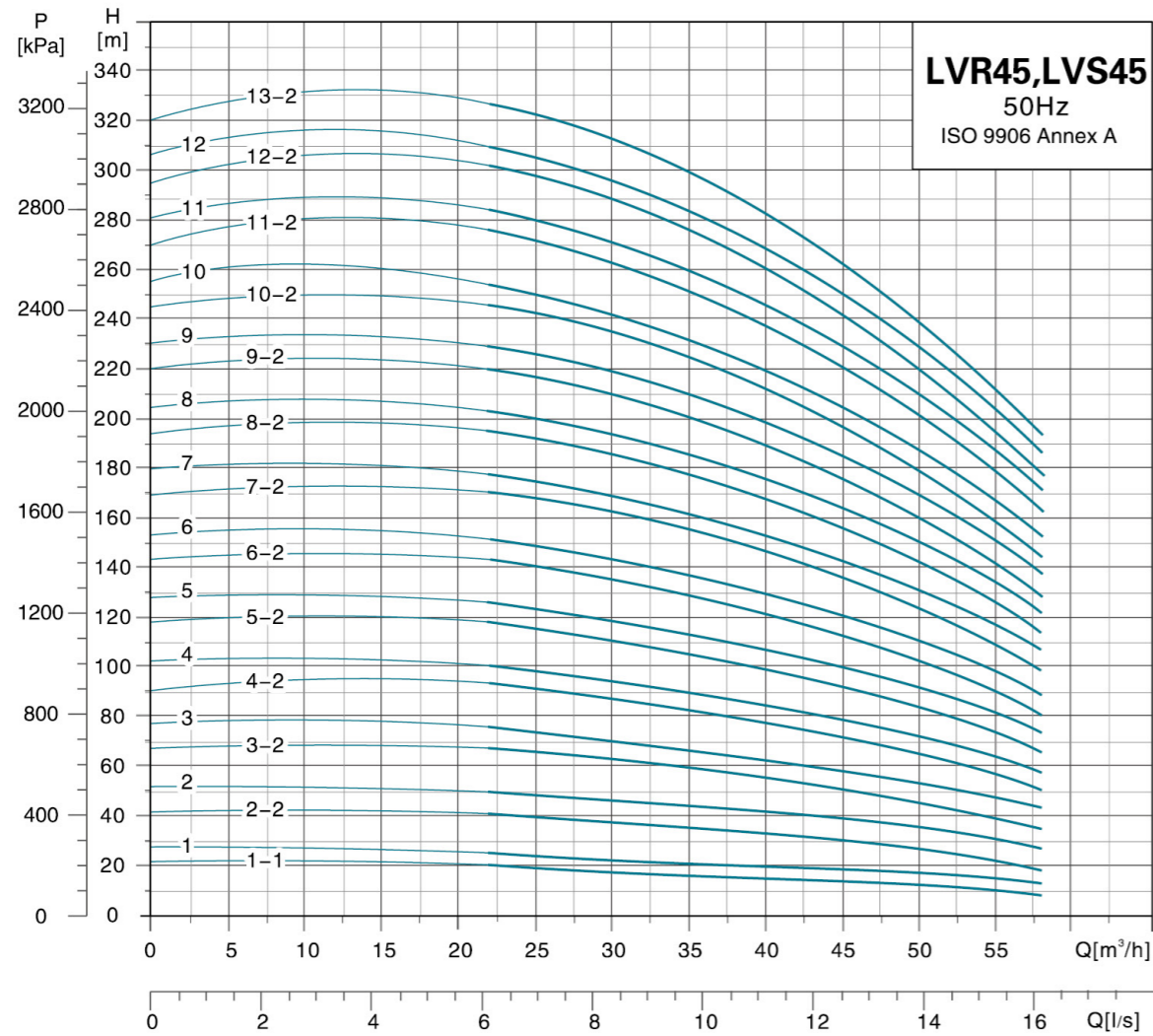

Dimension Drawing

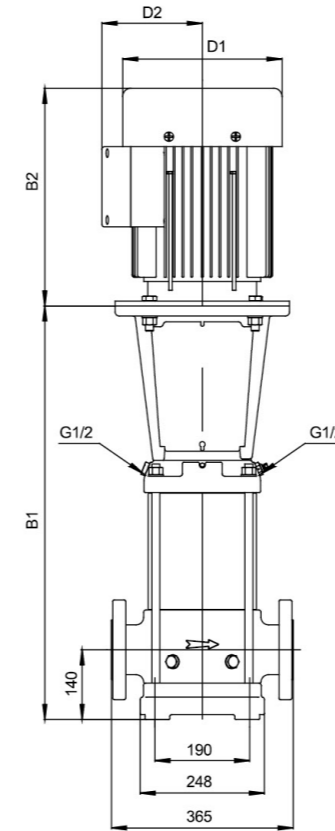

LVR

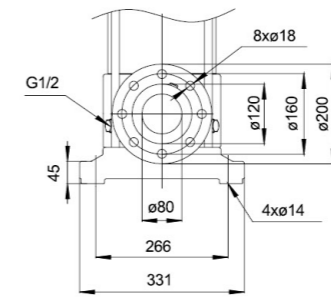

LVS

MODEL	DIN FLANGE(LVR, LVS)		D1	D2	N.W. (kgs)
	B1	B1+B2			
45-1-1	560	900	186	120	81
45-1	560	900	186	120	83.2
45-2-2	640	1037	210	142	111.3
45-2	640	1037	210	142	115.5
45-3-2	830	1329	254	175	157.6
45-3	830	1329	254	175	157.6
45-4-2	910	1409	254	175	173.1
45-4	910	1409	254	175	173.1
45-5-2	990	1550	330	250	225
45-5	990	1550	330	250	225
45-6-2	1070	1670	380	280	264.8
45-6	1070	1670	380	280	264.8
45-7-2	1150	1830	420	305	325.2
45-7	1150	1830	420	305	325.2
45-8-2	1230	1910	420	305	328.2
45-8	1230	1910	420	305	328.2
45-9-2	1310	1990	420	305	330.9
45-9	1310	1990	420	305	349
45-10-2	1390	2070	420	305	352.5
45-10	1390	2070	420	305	352.5
45-11-2	1470	2185	470	335	416.3
45-11	1470	2185	470	335	416.3
45-12-2	1550	2265	470	335	419.1
45-12	1550	2265	470	335	419.1
45-13-2	1630	2345	470	335	421.9

PN 16-25-40/DN 80

MODEL	POWER[kw]	Q[m³/h]	25	30	35	40	45	50	55	58
LVR(S)45-1-1	3		20	19.5	18	17	15	12.5	10.5	8
LVR(S)45-1	4		24	23	22	20.5	19	17.5	15	13
LVR(S)45-2-2	5.5		41	39	37	34	30.5	26.5	22	18
LVR(S)45-2	7.5		48.5	46.5	44.5	42	39	35	31	28
LVR(S)45-3-2	11		66	64	61	56.5	52	46	40	35
LVR(S)45-3	11		73.5	71	68	64	59.5	54	47.5	43
LVR(S)45-4-2	15		91	88	84	78.5	72	64.5	56	50
LVR(S)45-4	15		98.5	95	91	85.5	79.5	72.5	64	59
LVR(S)45-5-2	18.5		116	113	107	101	92.5	83.5	73	66
LVR(S)45-5	18.5		124	120	115	108	100	91.5	81	74
LVR(S)45-6-2	22		142	137	131	122	113	103	90	82
LVR(S)45-6	22		149	144	138	130	121	111	98	90
LVR(S)45-7-2	30		168	163	156	147	135	123	109	99
LVR(S)45-7	30		176	171	163	156	144	132	116	108
LVR(S)45-8-2	30		193	187	179	168	155	142	126	115
LVR(S)45-8	30		200	194	187	176	164	149	134	122
LVR(S)45-9-2	30		217	211	202	189	175	159	142	130
LVR(S)45-9	37		226	219	210	199	185	170	151	140
LVR(S)45-10-2	37		243	236	225	212	196	179	159	146
LVR(S)45-10	37		251	243	233	220	205	187	166	154
LVR(S)45-11-2	45		273	264	253	238	222	201	179	164
LVR(S)45-11	45		281	272	261	246	230	209	187	172
LVR(S)45-12-2	45		298	289	276	261	242	220	195	179
LVR(S)45-12	45		306	296	284	268	251	229	204	188
LVR(S)45-13-2	45		323	313	300	283	263	239	212	195

H(m)

Hydraulic Performance Curves

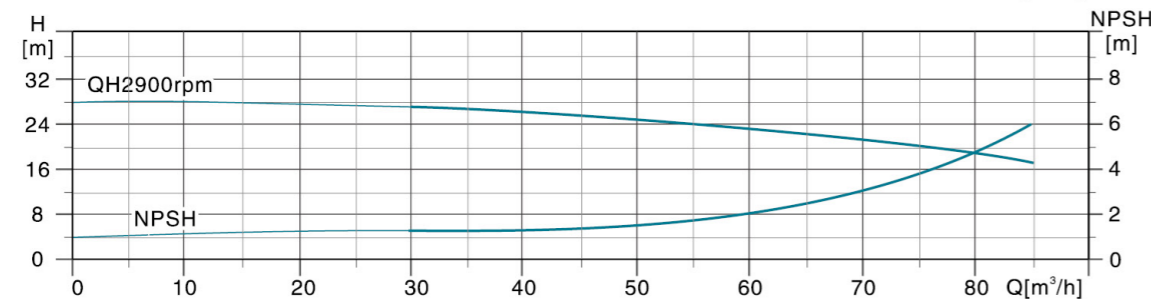
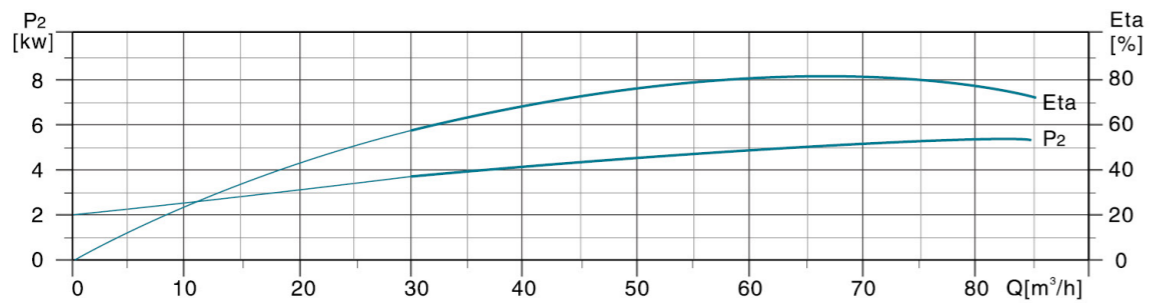
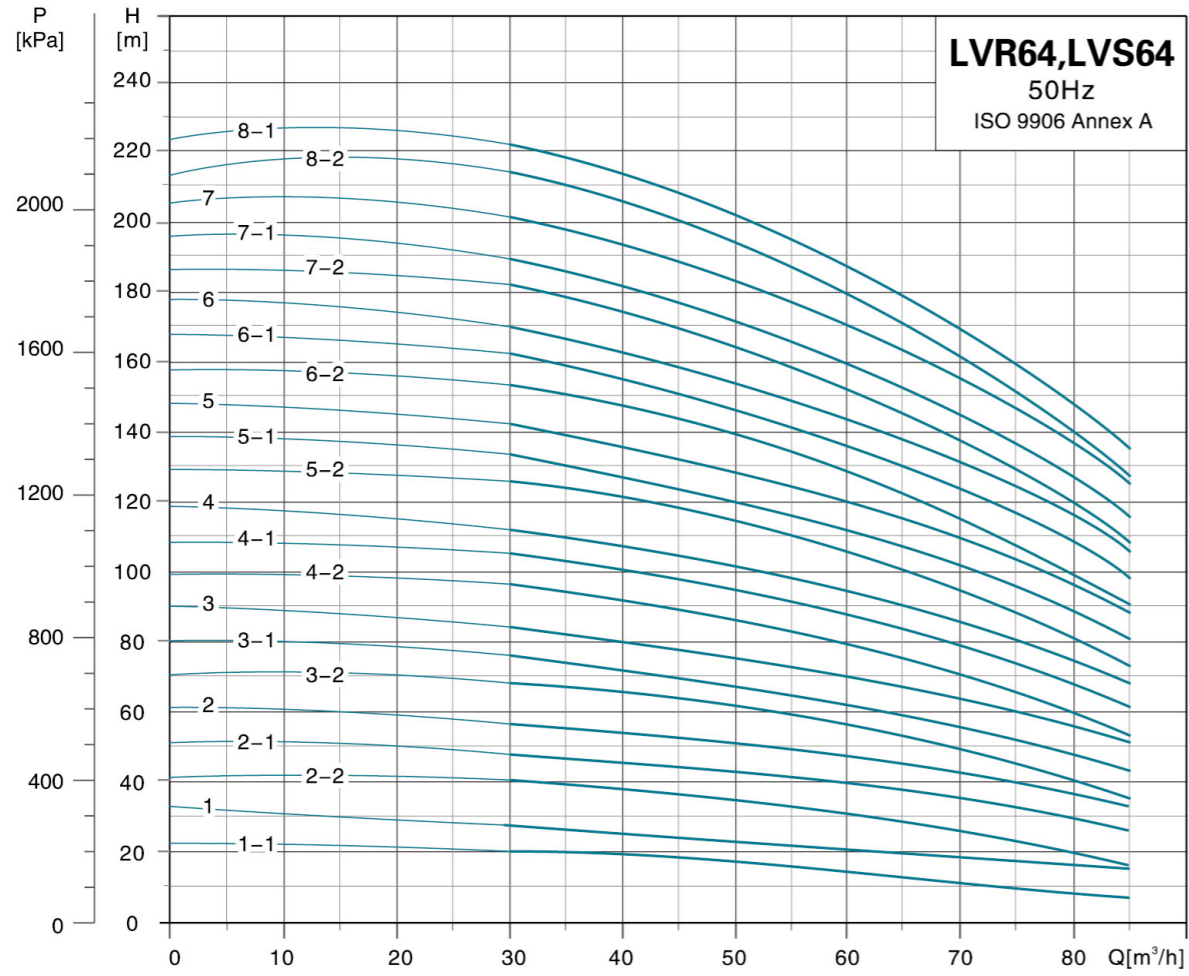

Dimension Drawing

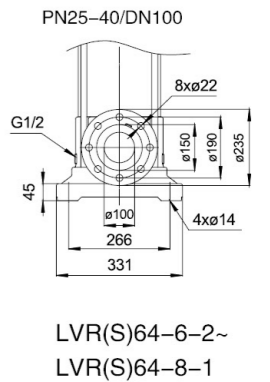
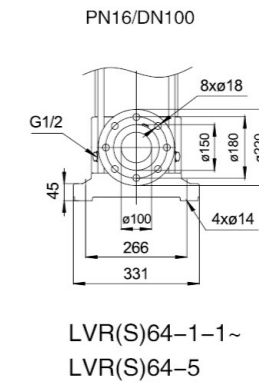
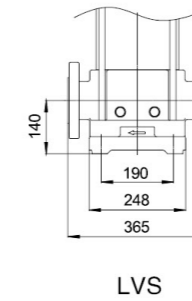
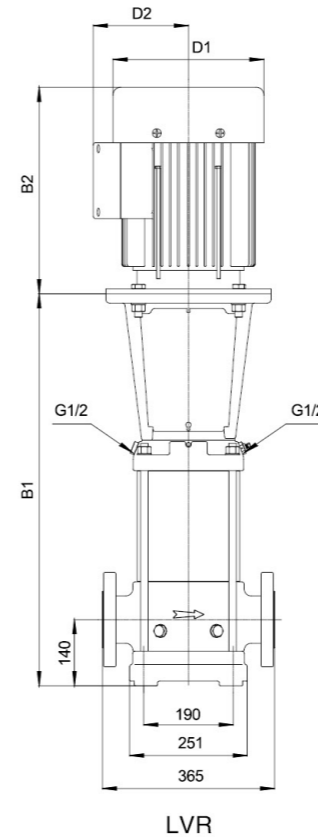

MODEL	DIN FLANGE(LVR, LVS)		D1	D2	N.W. (kgs)
	B1	B1+B2			
64-1-1	563	903	186	124	84.5
64-1	563	960	210	142	110.2
64-2-2	645	1042	210	142	117.4
64-2-1	755	1254	254	175	156
64-2	755	1254	254	175	156
64-3-2	838	1337	254	175	171.9
64-3-1	838	1337	254	175	171.9
64-3	838	1398	330	250	221
64-4-2	920	1480	330	250	223.9
64-4-1	920	1520	380	280	261
64-4	920	1520	380	280	261
64-5-2	1003	1683	420	305	321.5
64-5-1	1003	1683	420	305	321.5
64-5	1003	1683	420	305	321.5
64-6-2	1085	1765	420	305	324.5
64-6-1	1085	1765	420	305	341.2
64-6	1085	1765	420	305	341.2
64-7-2	1168	1848	420	305	344.9
64-7-1	1168	1848	420	305	345
64-7	1168	1883	470	335	407.3
64-8-2	1250	1965	470	335	410.7
64-8-1	1250	1965	470	335	410.4

MODEL	POWER[kW]	Q[m³/h]	30	40	50	64	70	80	85
LVR(S)64-1-1	4		20	19	17.5	14	12	8.5	6
LVR(S)64-1	5.5		27	25.5	23.5	21	20	17	15
LVR(S)64-2-2	7.5		40	38	35.5	29	25.5	19	15
LVR(S)64-2-1	11		48	45.5	42.5	37	34.5	29	25
LVR(S)64-2	11		55	52.5	49.5	44	41.5	36	33
LVR(S)64-3-2	15		68	65.5	60	52.5	48.5	40	35
LVR(S)64-3-1	15		75.5	72	67.5	59.5	55.5	47	42
LVR(S)64-3	18.5		83.5	80	76	68	64	56	51
LVR(S)64-4-2	18.5		96	92.5	87	75.5	70	59	52
LVR(S)64-4-1	22		104	100	94.5	83.5	78.5	67.5	61
LVR(S)64-4	22		112	107	102	91	85.5	74.5	69
LVR(S)64-5-2	30		126	122	115	101	94	80.5	73
LVR(S)64-5-1	30		134	129	122	109	102	88	81
LVR(S)64-5	30		141	136	129	116	109	96	89
LVR(S)64-6-2	30		154	148	140	124	115	99	90
LVR(S)64-6-1	37		162	156	148	132	124	108	98
LVR(S)64-6	37		170	163	155	139	131	116	107
LVR(S)64-7-2	37		182	176	166	147	138	119	109
LVR(S)64-7-1	37		190	183	173	155	145	126	110
LVR(S)64-7	45		202	194	184	165	155	136	126
LVR(S)64-8-2	45		214	207	196	174	163	140	128
LVR(S)64-8-1	45		222	214	203	181	170	148	135

Hydraulic Performance Curves

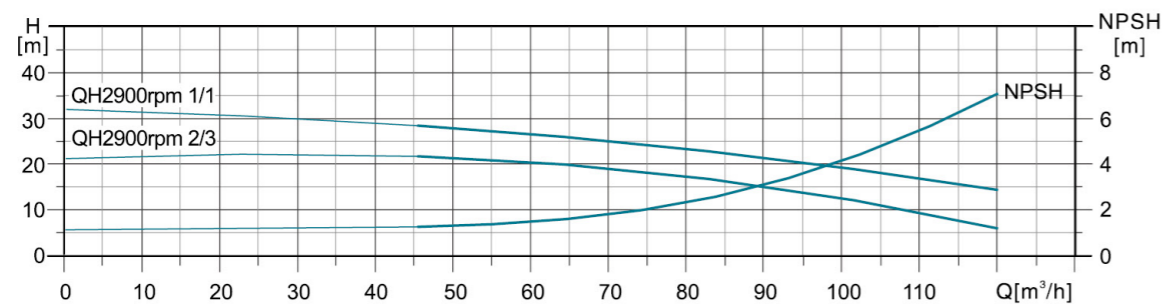
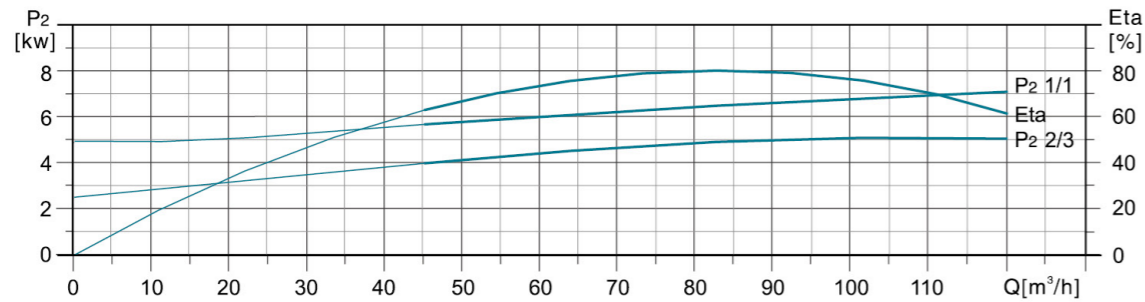
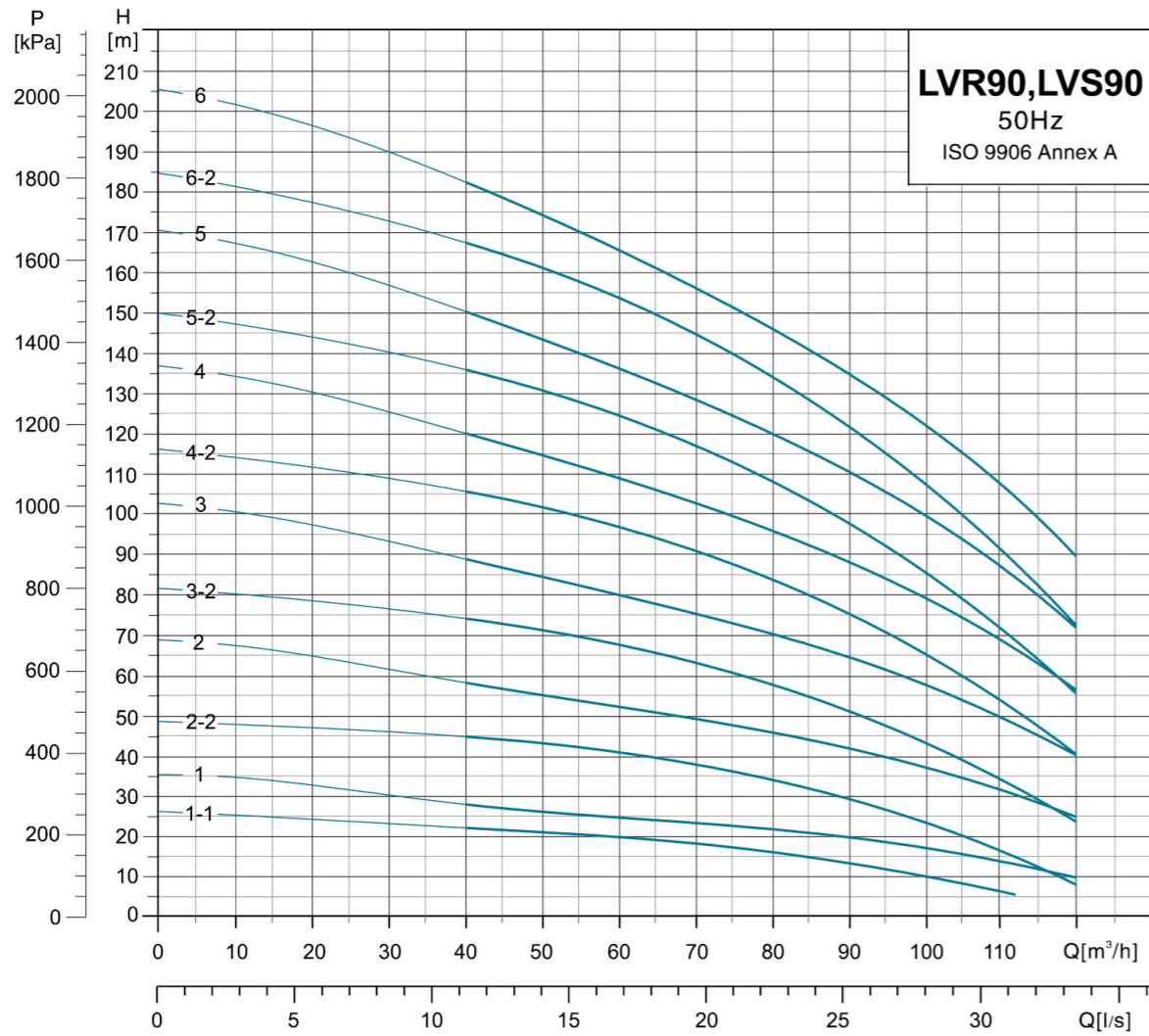

Dimension Drawing

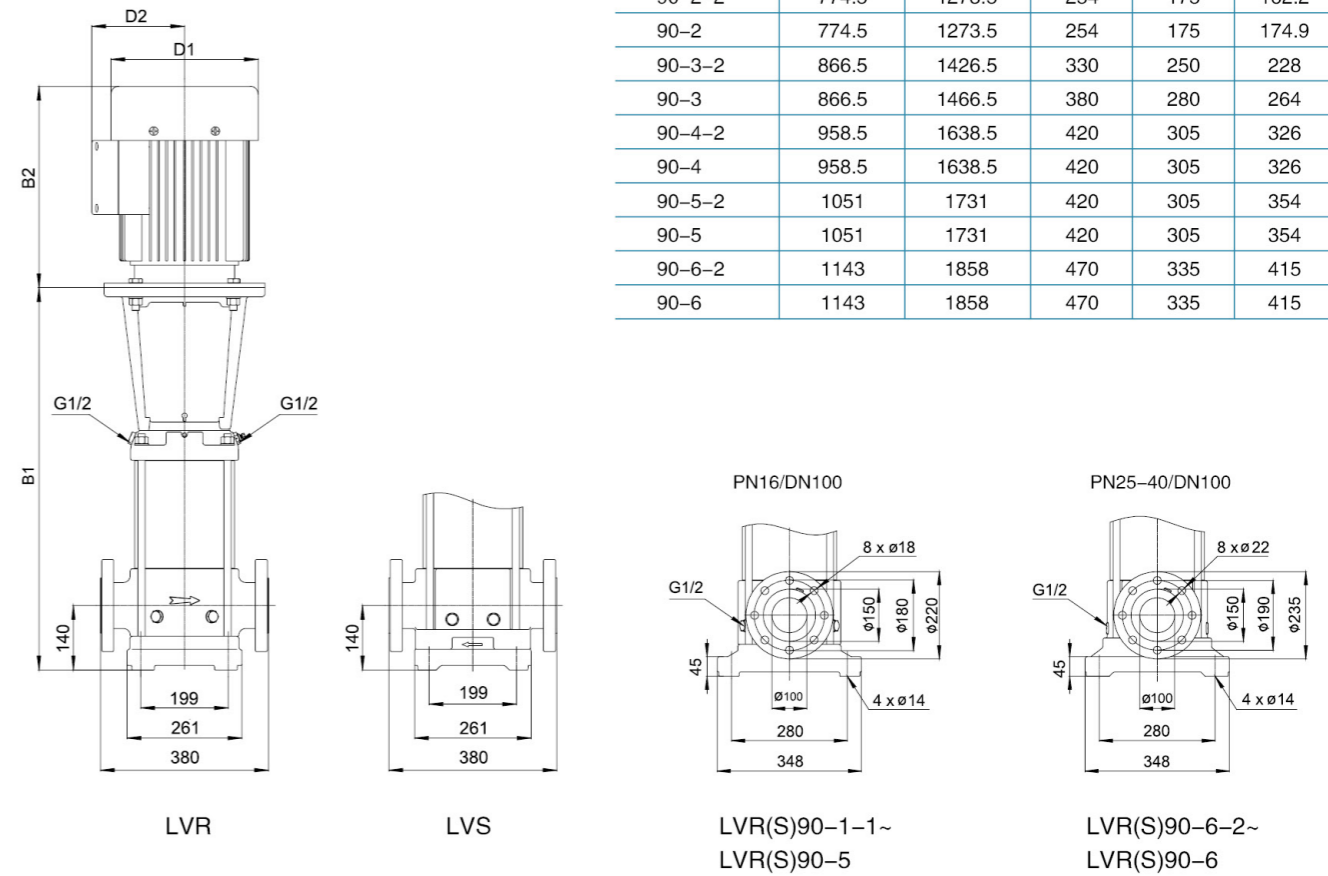

MODEL	DIN FLANGE(LVR, LVS)		D1	D2	N.W. (kgs)
	B1	B1+B2			
90-1-1	572.5	969.5	210	142	116
90-1	572.5	969.5	210	142	121.2
90-2-2	774.5	1273.5	254	175	162.2
90-2	774.5	1273.5	254	175	174.9
90-3-2	866.5	1426.5	330	250	228
90-3	866.5	1466.5	380	280	264
90-4-2	958.5	1638.5	420	305	326
90-4	958.5	1638.5	420	305	326
90-5-2	1051	1731	420	305	354
90-5	1051	1731	420	305	354
90-6-2	1143	1858	470	335	415
90-6	1143	1858	470	335	415

MODEL	POWER[kW]	Q[m³/h]	40	50	60	70	80	90	100	110	120
LVR(S)90-1-1	5.5	H(m)	22	21	20	18	16	14	10.5	6.5	-
LVR(S)90-1	7.5		38	26	25	23.5	22	20	17.5	14	10
LVR(S)90-2-2	11		45	43	41	38	34.5	30	24	17	8
LVR(S)90-2	15		58	55	52	49	46	42.5	37.5	31.5	25
LVR(S)90-3-2	18.5		74	71.5	68	63.5	58	51.5	44	35	24
LVR(S)90-3	22		88	84.5	80	75.5	70.5	65	58.5	50.5	40
LVR(S)90-4-2	30		106	102	97	91	84.5	76	65.5	54	40
LVR(S)90-4	30		120	114	109	103	96	88.5	79.5	69.5	57
LVR(S)90-5-2	37		136	131	125	118	109	98.5	86.5	72	55
LVR(S)90-5	37		150	144	136	129	121	111	101	87	72
LVR(S)90-6-2	45		166	161	154	145	135	123	108	91.5	72
LVR(S)90-6	45		182	175	166	156	146	135	123	108	90

Hydraulic Performance Curves

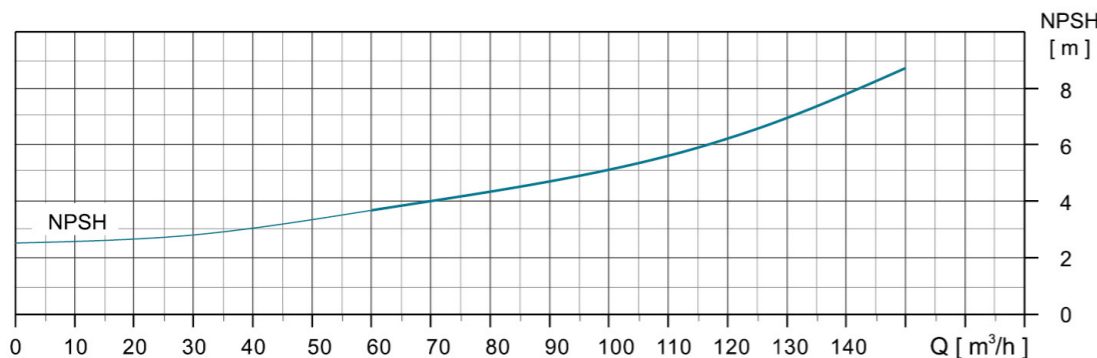
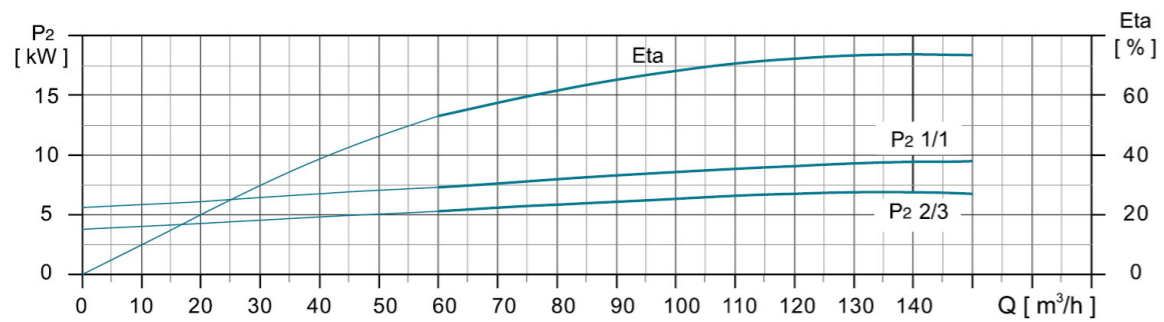
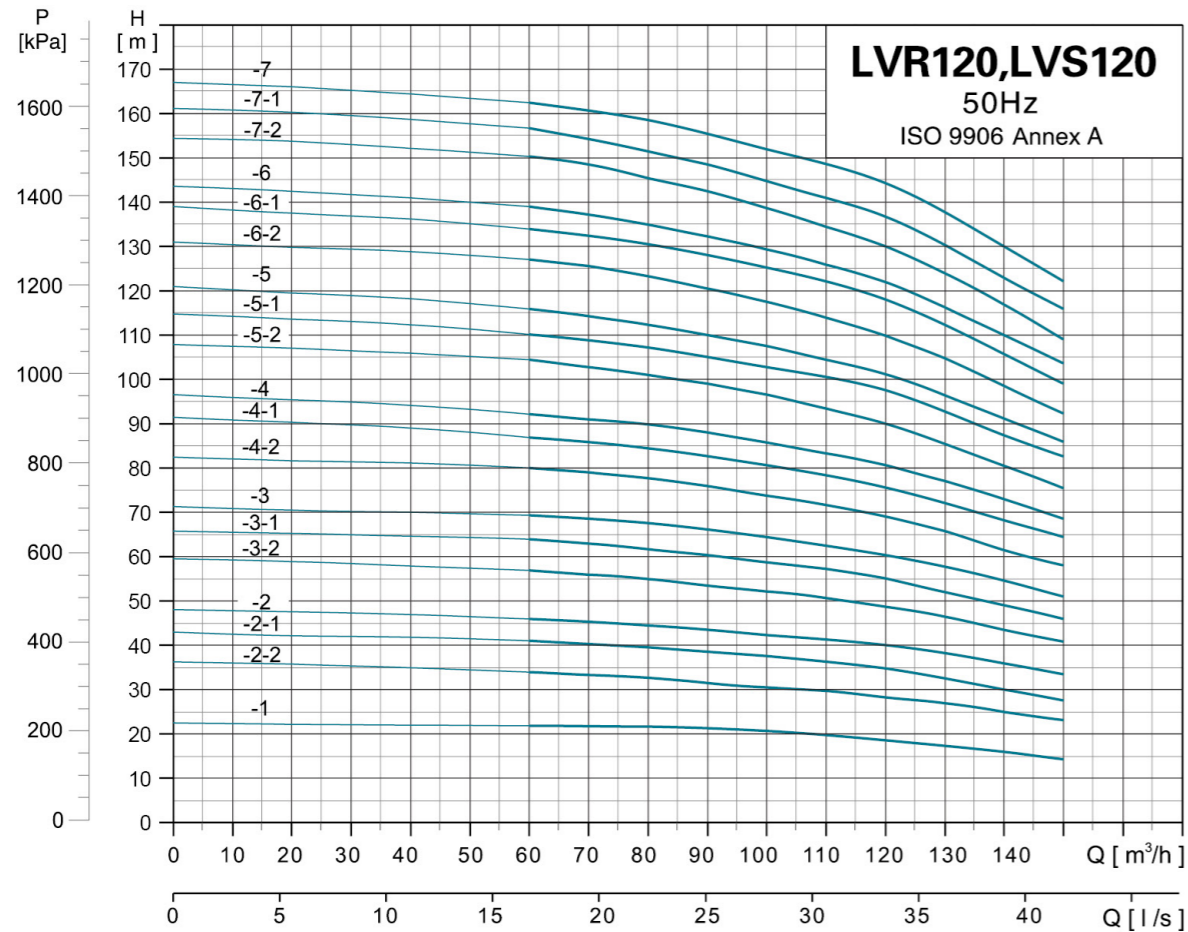

Dimension Drawing

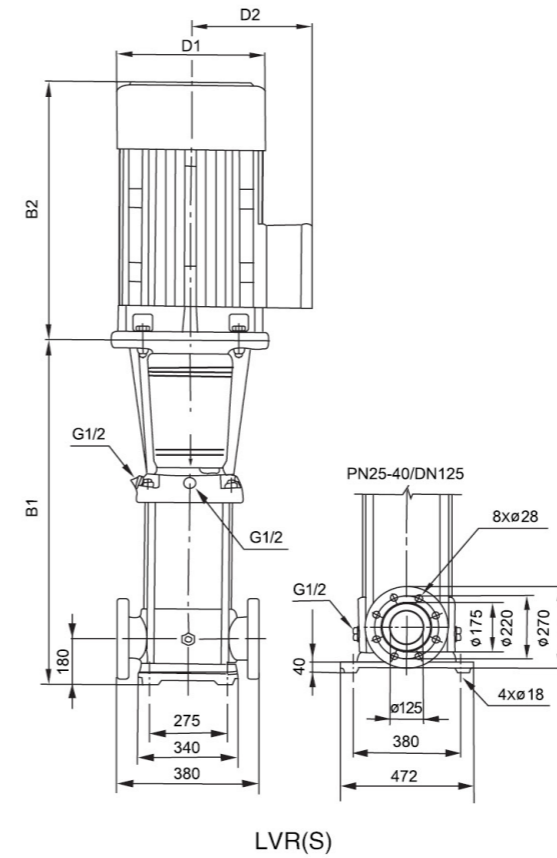

MODEL	DIN FLANGE(LVR, LVS)		D1	D2	N.W. (kgs)
	B1	B1+B2			
120-1	840	1339	254	175	186
120-2-2	1000	1499	254	175	210
120-2-1	1000	1560	330	250	250
120-2	1000	1600	380	280	285
120-3-2	1160	1840	420	305	326
120-3-1	1160	1840	420	305	360
120-3	1160	1840	420	305	360
120-4-2	1320	2000	420	305	400
120-4-1	1320	2000	420	305	400
120-4	1320	2035	470	335	460
120-5-2	1480	2195	470	335	470
120-5-1	1480	2195	470	335	470
120-5	1510	2295	510	370	575
120-6-2	1670	2455	510	370	585
120-6-1	1670	2455	510	370	585
120-6	1670	2515	580	410	705
120-7-2	1830	2675	580	410	715
120-7-1	1830	2675	580	410	715
120-7	1830	2675	580	410	715

MODEL	POWER[kW]	Q[m³/h]	60	70	80	90	100	110	120	130	140	150
LVR(S)120-1	11		22	21.8	21.6	21	20.5	19.5	18.5	17	16	15
LVR(S)120-2-2	15		34	33.6	33	31	30.2	30	28.5	27	25	24
LVR(S)120-2-1	18.5		41	40	39.5	38.5	37	36.5	34.5	32.5	30	27.5
LVR(S)120-2	22		46	45	44.5	43.5	42.4	41	40	38	36	33.5
LVR(S)120-3-2	30		57	56	55	53.5	52	51	49	46.5	43.5	41
LVR(S)120-3-1	30		64	63	62	60	58.5	57.5	55.5	52	49	46
LVR(S)120-3	30		69.5	68.5	67.5	66	64.4	62.5	61	57.5	54.5	51
LVR(S)120-4-2	37		80.5	79	78	76	73.5	72	69	66	61.5	58
LVR(S)120-4-1	37		87	86	84.5	82	80	78	76	72	68	64.5
LVR(S)120-4	45		92.5	91	90	88	85.5	83	81	77	73	68.5
LVR(S)120-5-2	45		104.5	103	101	99	96	93	90	85.5	80.5	75.5
LVR(S)120-5-1	45		110.5	109	107.5	105	102	100	97	92	86.5	83
LVR(S)120-5	55		115.5	114	113	110	107.5	104.5	101.5	96	91	86
LVR(S)120-6-2	55		128	125.5	123	121	117.3	113.5	110	104.5	98.5	92.5
LVR(S)120-6-1	55		134	132	130.5	127	124	121	118	111	105	100
LVR(S)120-6	75		139	137	135	132	128.8	126	123	116	110	104
LVR(S)120-7-2	75		151	148	145.5	143	138.6	134	130	123.5	116.5	109
LVR(S)120-7-1	75		156.5	154	152	148.5	144.5	141	137.5	130	123	116.5
LVR(S)120-7	75		162.5	160.5	158.5	155	151	148	145	137	129	123

Hydraulic Performance Curves

Dimension Drawing

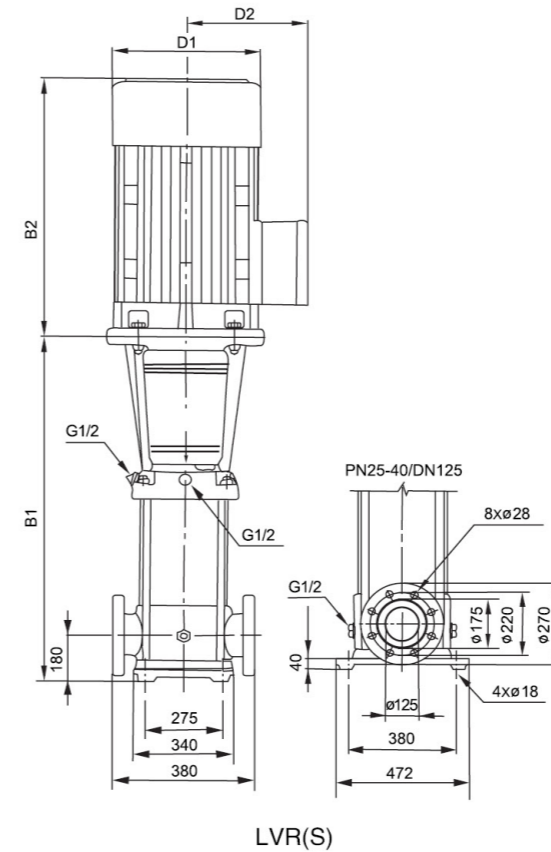
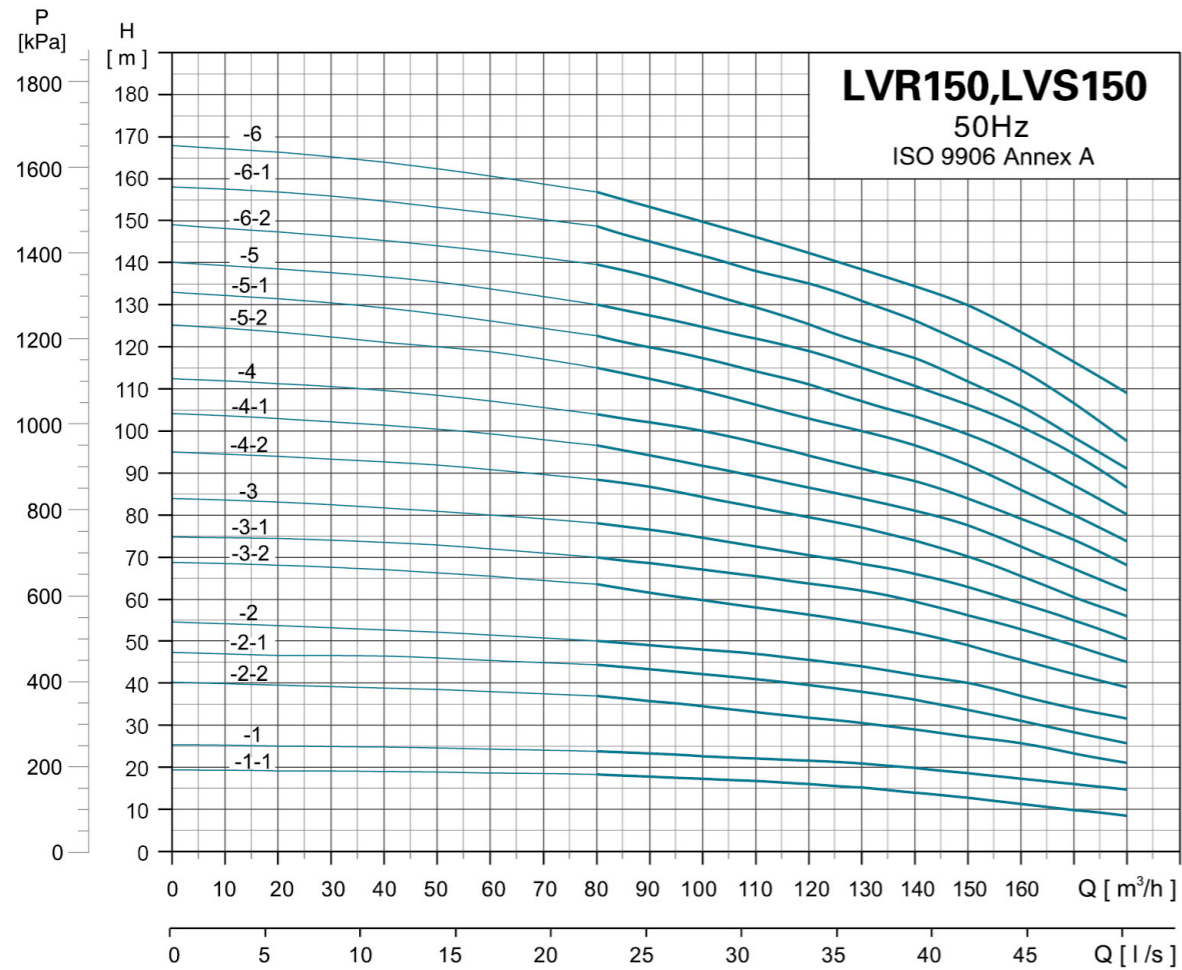

MODEL	DIN FLANGE(LVR, LVS)		D1	D2	N.W. (kgs)
	B1	B1+B2			
150-1-1	840	1339	254	175	186
150-1	840	1339	254	175	200
150-2-2	1000	1560	330	250	250
150-2-1	1000	1600	380	280	295
150-2	1000	1680	420	305	317
150-3-2	1160	1840	420	305	360
150-3-1	1160	1840	420	305	360
150-3	1160	1840	420	305	385
150-4-2	1320	2035	470	335	460
150-4-1	1320	2035	470	335	460
150-4	1350	2135	510	370	560
150-5-2	1510	2295	510	370	570
150-5-1	1510	2355	580	410	690
150-5	1510	2355	580	410	690
150-6-2	1670	2515	580	410	700
150-6-1	1670	2515	580	410	700
150-6	1670	2515	580	410	700

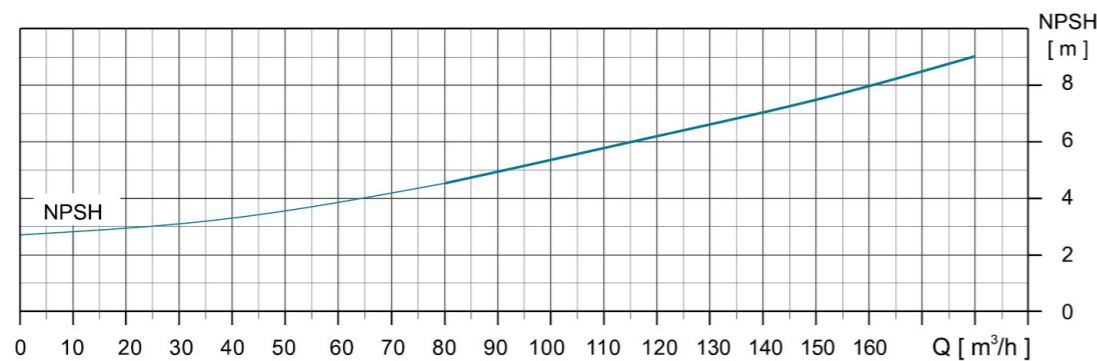
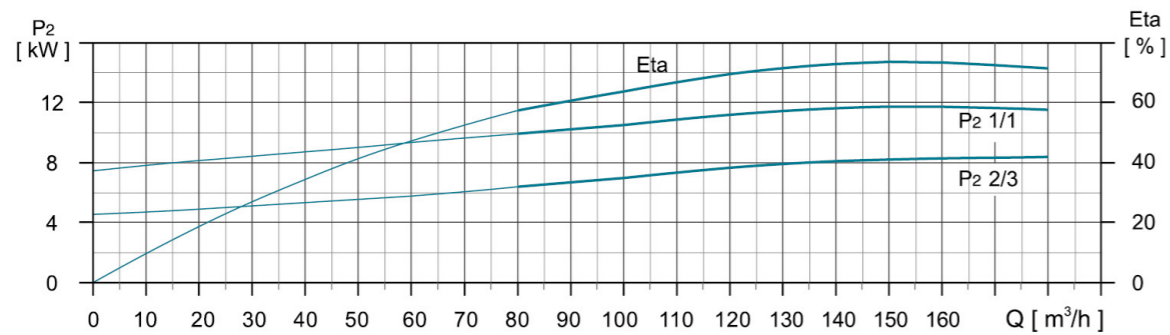

MODEL	POWER[kW]	Q[m³/h]	80	90	100	110	120	130	140	150	160	170	180
LVR(S)150-1-1	11	H(m)	18.3	17.8	17.3	17	16	15	14	12.5	11	10	8.5
LVR(S)150-1	15		24	23	22.5	22	21.5	20.5	20	18.5	17	16	15
LVR(S)150-2-2	18.5		37	35.5	34	33	32	31	29	27.5	26	23	21
LVR(S)150-2-1	22		44.3	43	42	40	39	38.5	37.5	35	33	30	27
LVR(S)150-2	30		50	49	48	47	45.5	44	42	40	37	34	32
LVR(S)150-3-2	30		63.5	61	59	57.5	56	54.5	53	49	45.5	42	39
LVR(S)150-3-1	37		70	68	67	65	63	62	60	56	53	49	45
LVR(S)150-3	37		78	76.5	75	73	70.5	68	66	63	59	55	50.5
LVR(S)150-4-2	45		89	87	84	81.5	79	77	74.5	70.5	65.5	60	56
LVR(S)150-4-1	45		96.5	94	91.5	89	86.5	84	81.5	77	72.5	67	62
LVR(S)150-4	55		104	102	100	97	95	91	88	84	79.5	74	68
LVR(S)150-5-2	55		115.5	112	109	106	102.5	100	97	92	86	79	73.5
LVR(S)150-5-1	75		122.5	119.5	117	113.5	111.5	107.5	104.5	99	93.5	87	80
LVR(S)150-5	75		130	127.5	125	121	119	115	111.5	106.5	101	94.5	86.5
LVR(S)150-6-2	75		140	137	133	130	126	121	118	112	106	98	91
LVR(S)150-6-1	75		148.5	145	141.7	137.5	135	131	127	120.5	114.5	106.5	97.5
LVR(S)150-6	75	157	153	149	145	142	139.5	137	130	123.5	116	109	

Hydraulic Performance Curves

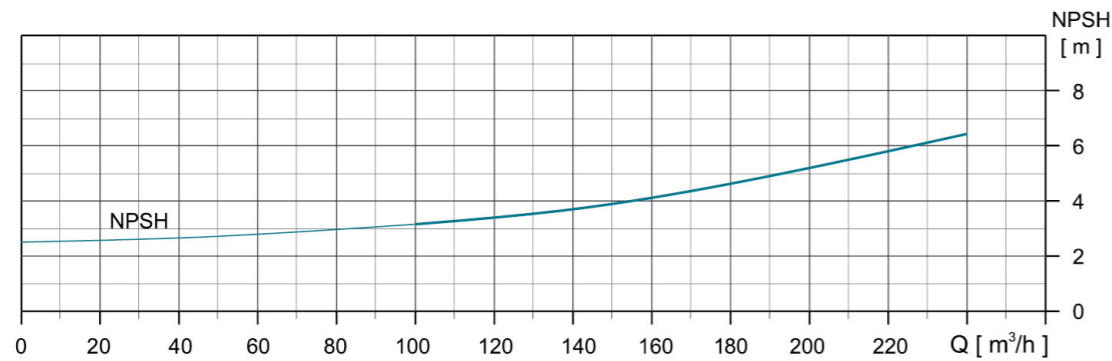
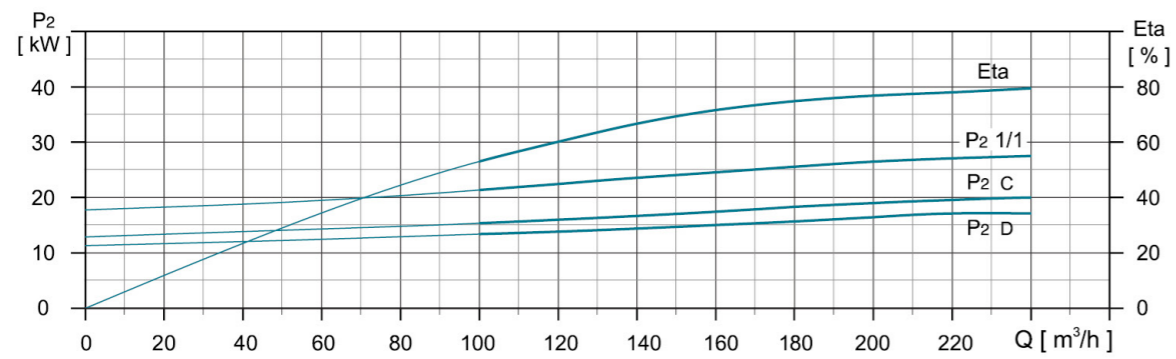
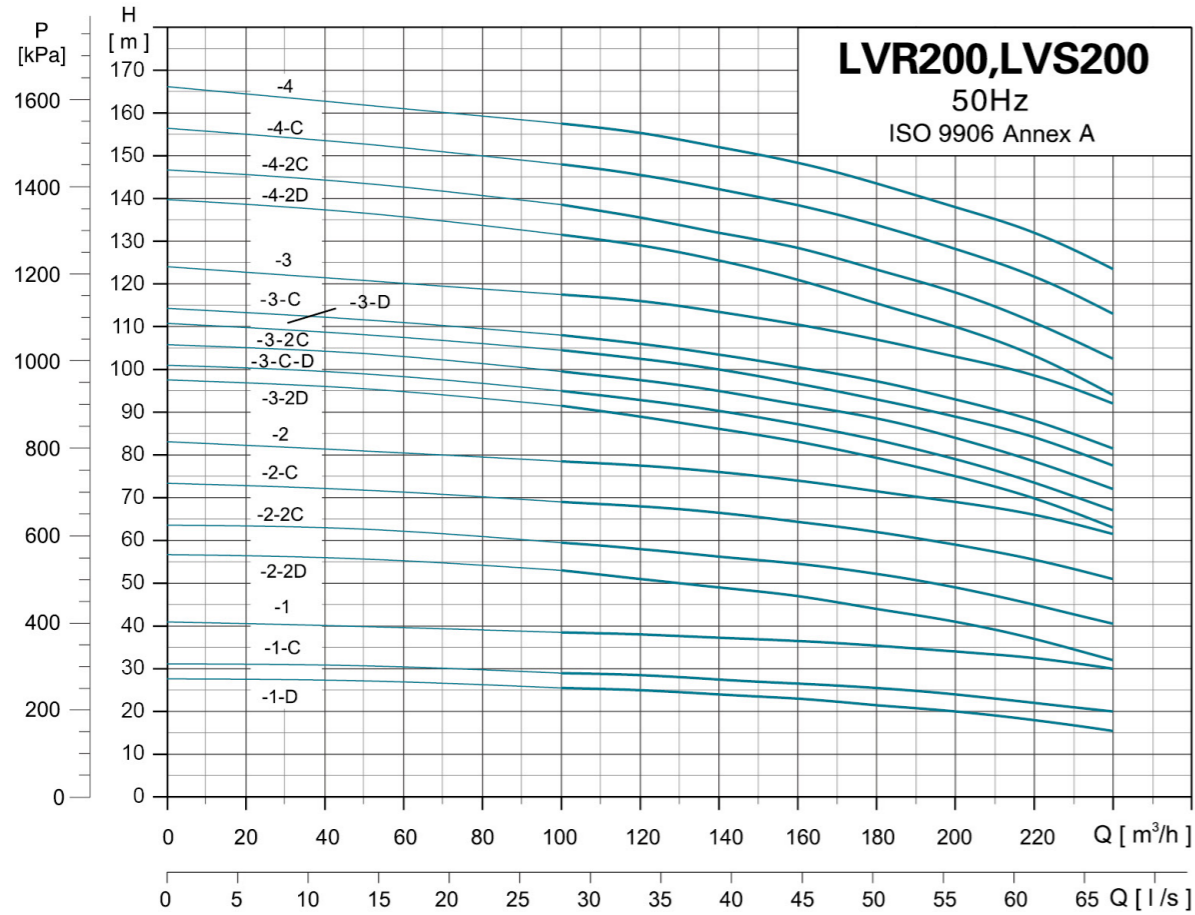

Dimension Drawing

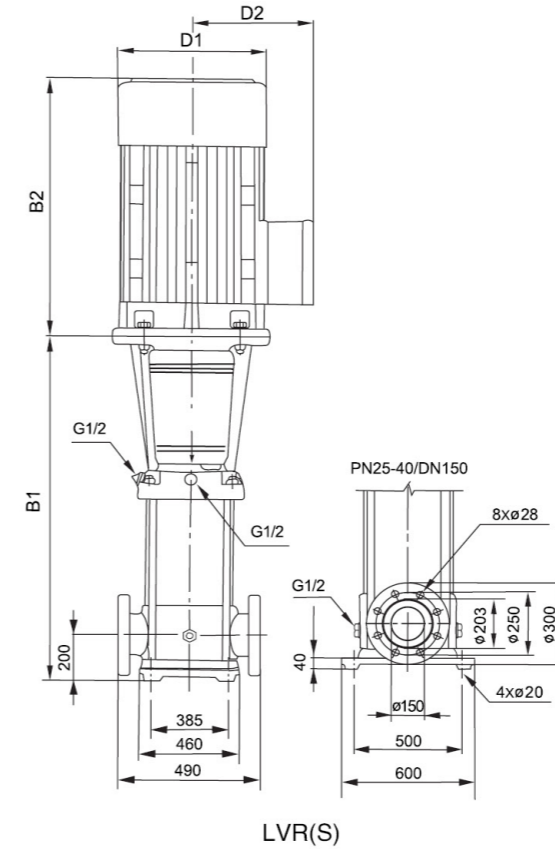

MODEL	DIN FLANGE(LVR, LVS)		D1	D2	N.W. (kgs)
	B1	B1+B2			
200-1-D	907	1467	330	250	311
200-1-C	907	1507	380	280	347
200-1	907	1587	420	305	403
200-2-2D	1101	1781	420	305	447
200-2-2C	1101	1816	470	335	504
200-2-C	1131	1916	510	370	595
200-2	1131	1916	510	370	595
200-3-2D	1325	2170	580	410	748
200-3-C-D	1325	2170	580	410	748
200-3-2C	1325	2170	580	410	748
200-3-D	1325	2170	580	410	748
200-3-C	1325	2170	580	410	748
200-3	1325	2220	580	410	817
200-4-2D	1519	2414	580	410	830
200-4-2C	1519	2619	645	530	1180
200-4-C	1519	2619	645	530	1180
200-4	1519	2619	645	530	1180

MODEL	POWER[kW]	Q[m³/h]	100	120	140	160	180	200	220	240
LVR(S)200-1-D	18.5	H(m)	25.5	25	24	23	21.5	20	18	15.5
LVR(S)200-1-C	22		29	28.5	27.5	26.5	25.5	24	22	20
LVR(S)200-1	30		38.5	38	37.5	36.5	35	34	32.5	30
LVR(S)200-2-2D	37		53	51	49	47	44	41	37	32
LVR(S)200-2-2C	45		59.5	58	56	54	52.5	49	44.5	40.5
LVR(S)200-2-C	55		69	68	66	64	62	59	55.5	51
LVR(S)200-2	55		78.5	77.5	76	74	71.5	69	66	61.5
LVR(S)200-3-2D	75		91.5	89	86.5	83.5	79	75	70	63
LVR(S)200-3-C-D	75		95	93	90	87	83.5	79	73.5	67
LVR(S)200-3-2C	75		99.5	97.5	94.5	91.5	89	84	78.5	72
LVR(S)200-3-D	75		104.5	102.5	100	97	93	89	84.5	77.5
LVR(S)200-3-C	75		108	106	103.5	100.5	97.5	93	88	81.5
LVR(S)200-3	90		117.5	116	113.5	110.5	107	103	99	92
LVR(S)200-4-2D	90		131.5	129	125.5	121	115.5	110	103.5	94
LVR(S)200-4-2C	110		138.5	136	132	128	124	118	111	102.5
LVR(S)200-4-C	110		148	145.5	142.5	138	134	128	122	113
LVR(S)200-4	110		157.5	155.5	152.5	148	143.5	138	132.5	123.5



Application

- Water supply: Pressure boosting for main pipes and high-rise buildings
- Industrial pressure boosting: Water system, cleaning system, high pressure washing system and firefighting system
- Pressure boosting for pressure tank, sprinkling irrigation and trichling irrigation
- Air conditioner, cooling system and industrial cleaning

Features

- Economic vertical multistage pumps
- Applicable for a wide scope of different temperatures, flow rates and pressure ranges
- Water inlet and outlet can be rotated for proper assembly in accordance with installation requirement
- Easy installation and maintenance
- Advanced hydraulic model design, featuring stable operation and high efficiency
- Cast iron water inlet and outlet with special anti-rust treatment
- High-strength engineering plastic flow passage components
- Reliable stainless steel welded shaft

Working Conditions

- Liquid temperature: +5°C ~ 60°C
- Max. ambient temperature: +40°C
- Max. pressure: 15 bar
- Altitude: up to 1000 m
- Standard voltage: Single-phase: 220~240V/50Hz
Three-phase: 380~415V/50Hz

Identification Codes

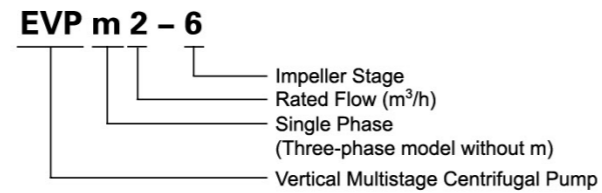

Scope of Performance

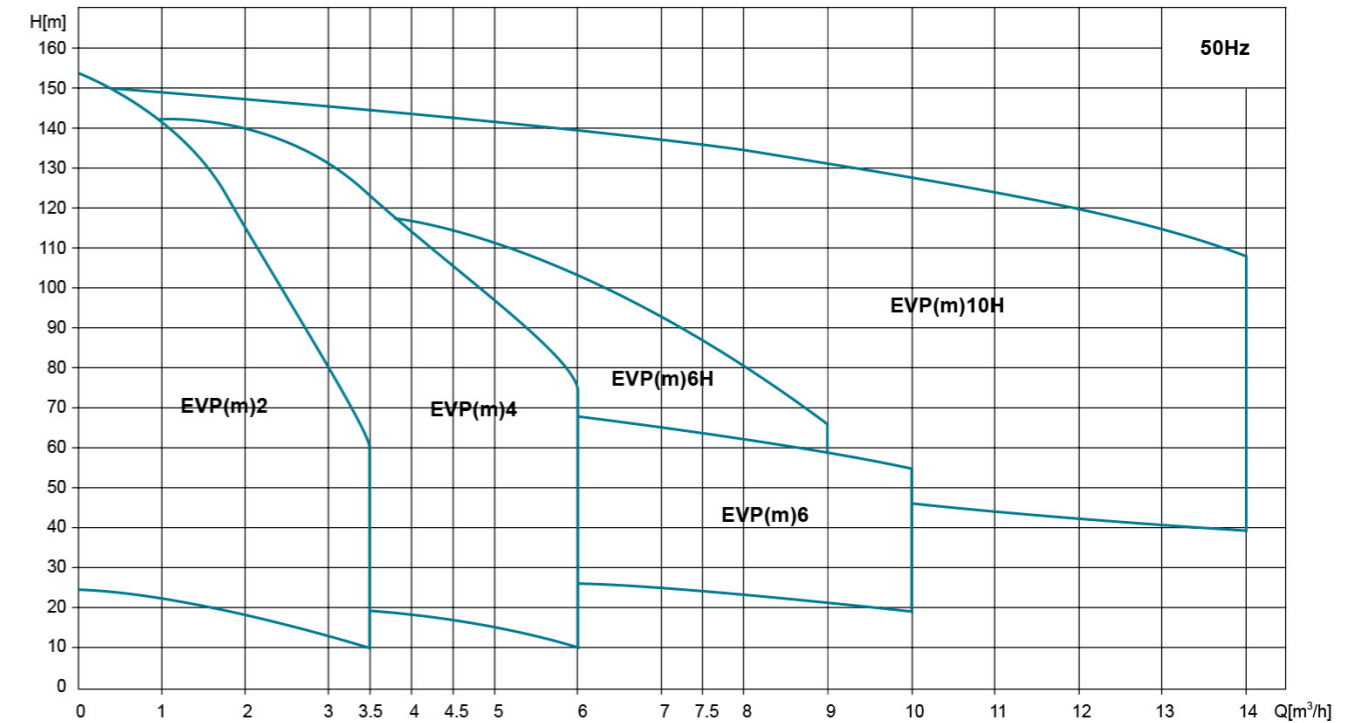

Hydraulic Performance Curves

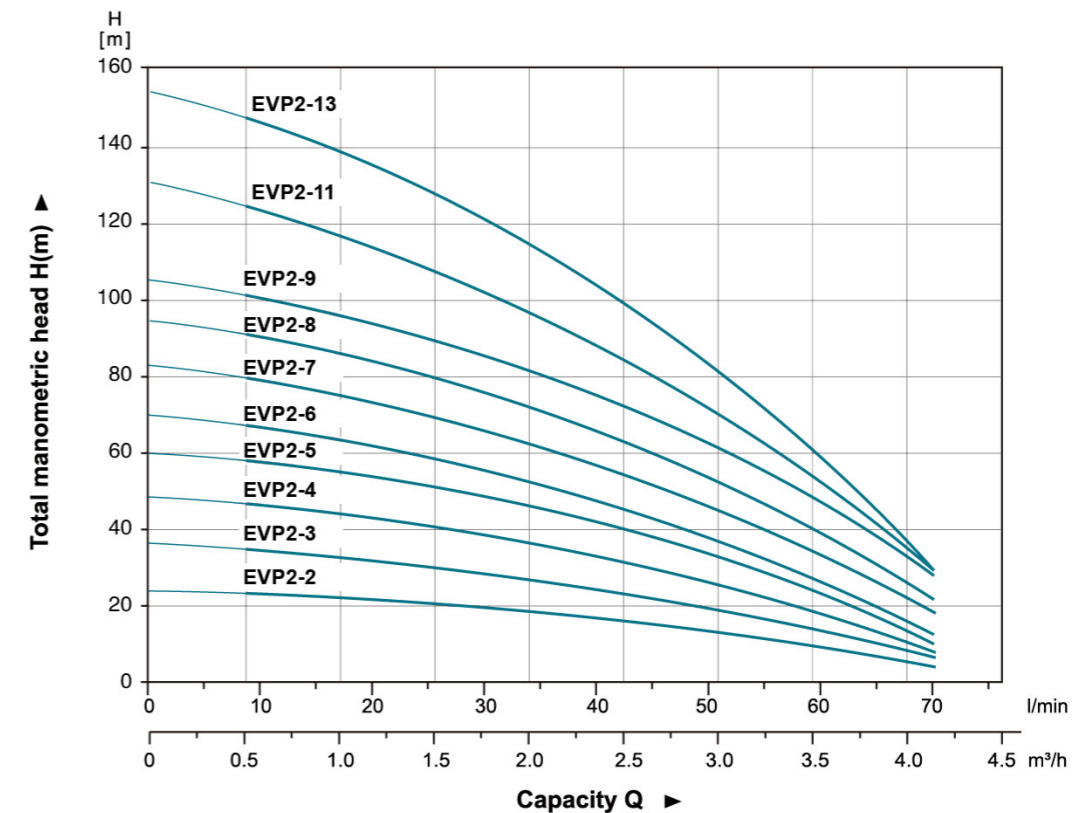

Materials Table

No.	Part	Material
1	Fan cover	08F
2	Fan	PP
3	Rear cover	Cast iron
4	Bearing	
5	Stator	
6	Rotor	
7	Gasket	Rubber
8	Flange	Cast iron
9	Motor bracket	Aluminum
10	Mechanical seal	Ceramic/Carbon
11	Pump barrel	AISI 304
12	Impeller	Plastic
13	Diffuser	Plastic
14	Last stage diffuser	Plastic
15	Capacitor box	Plastic

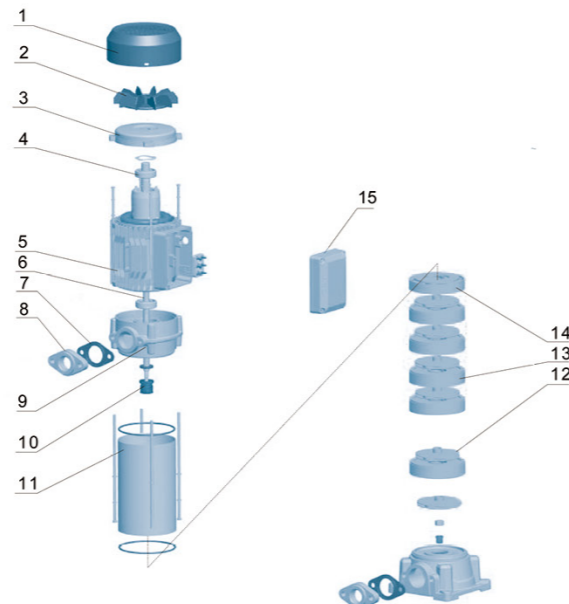

Hydraulic Performance Curves

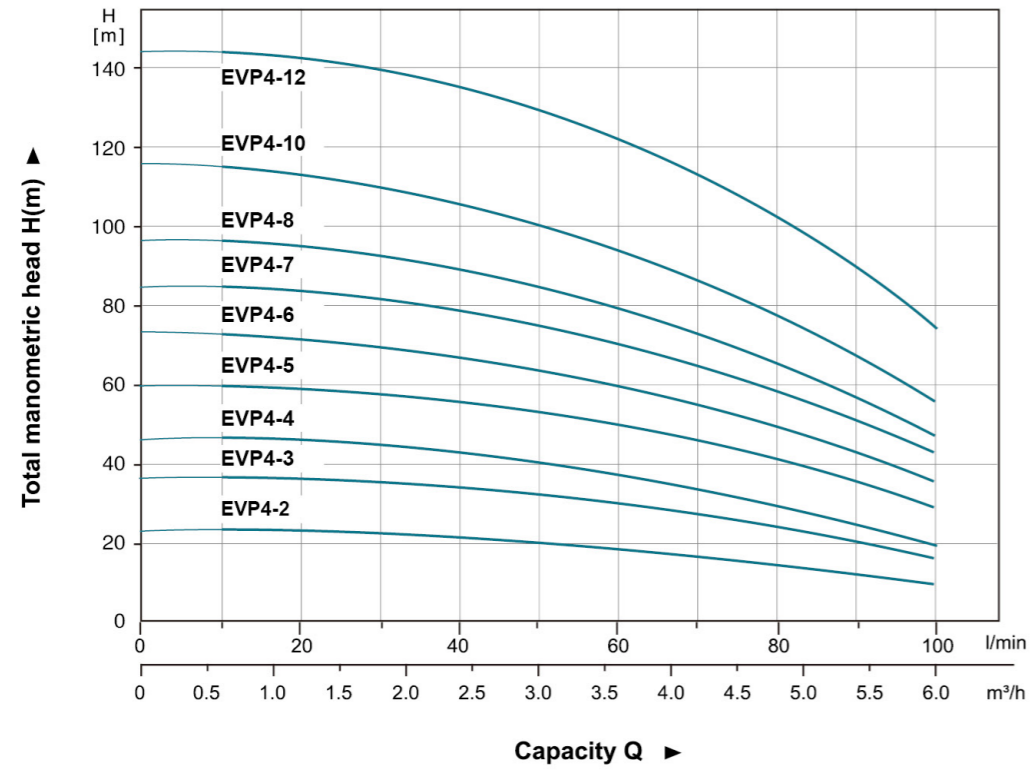

Hydraulic Performance Curves

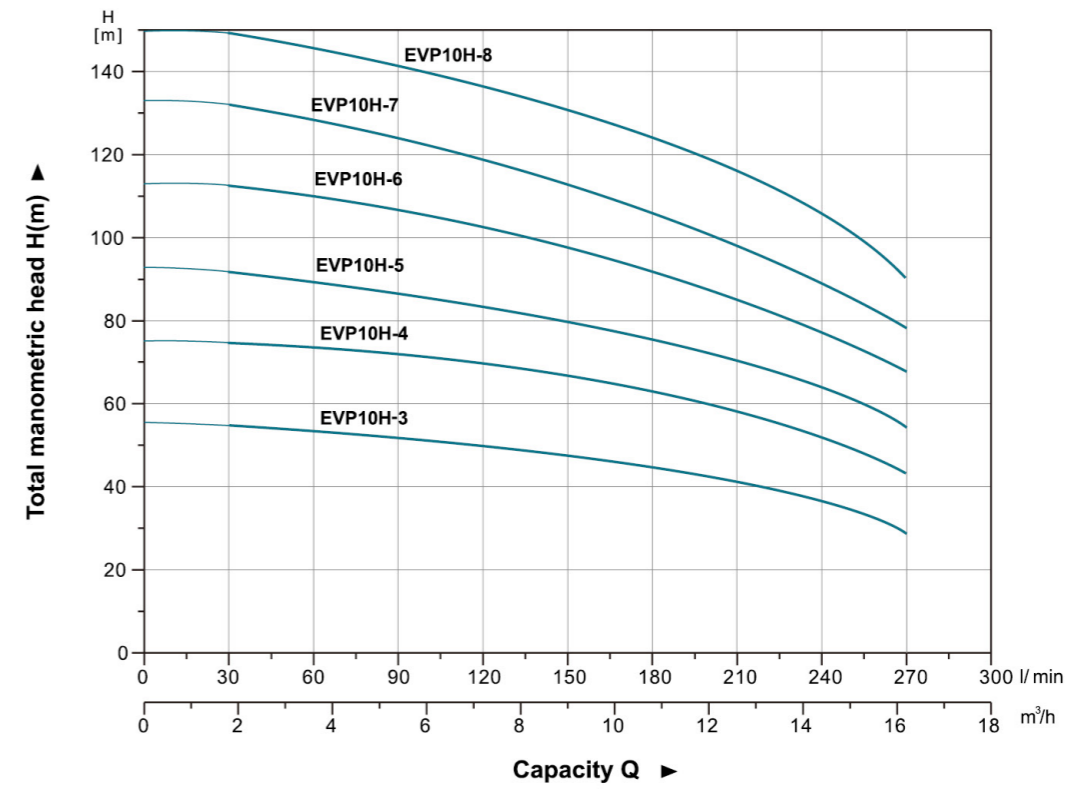
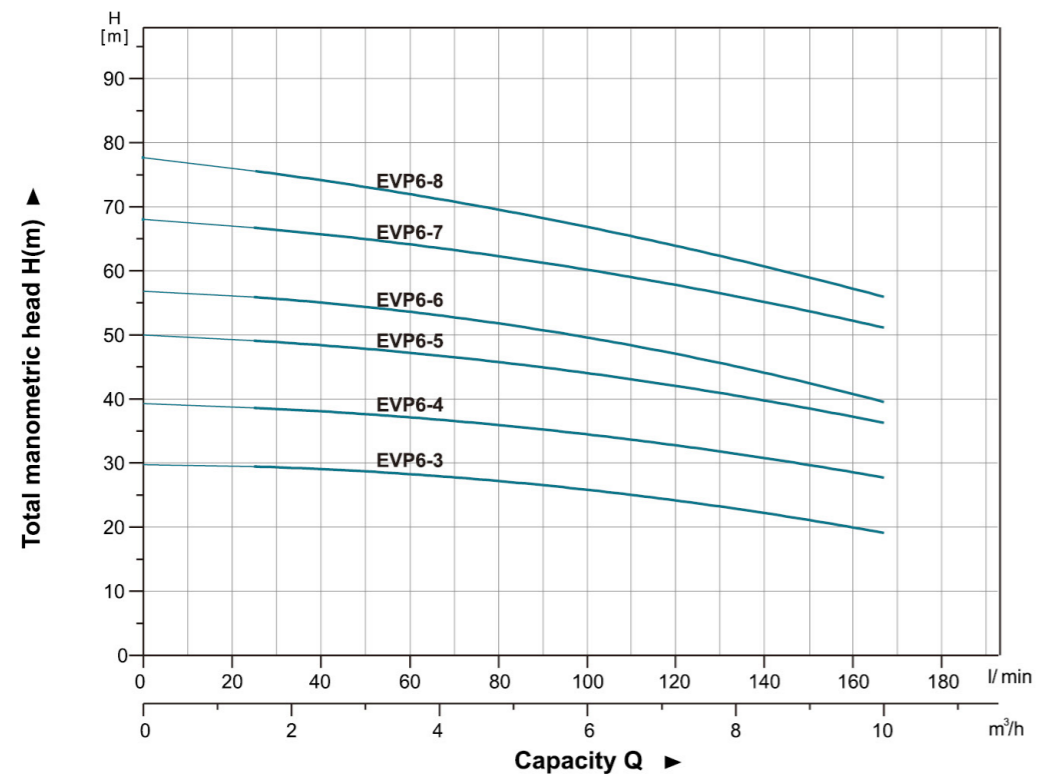
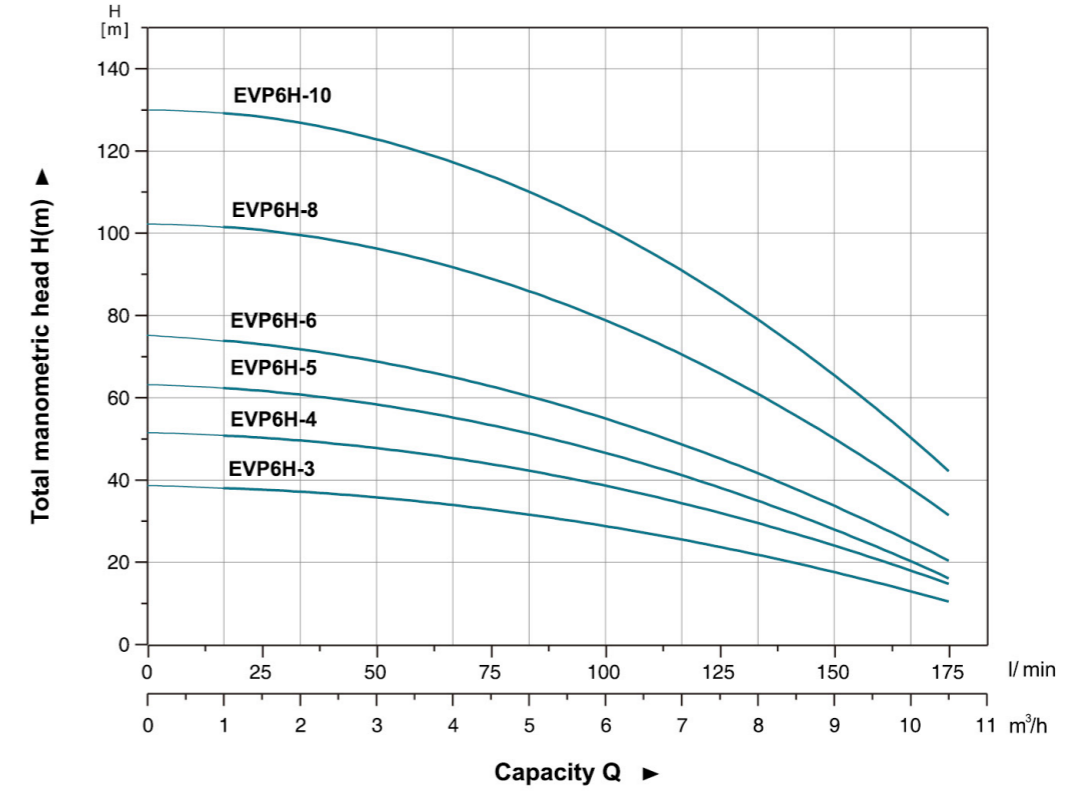

Technical Data

Model		Power (P2)		Q (m³/h)	0	1	2	3	4
Single-phase	Three-phase	kW	HP	Q (l/min)	0	16.7	33.3	50	66.7
EVPm2-2	EVP2-2	0.37	0.5	H (m)	24	23	18	13	6
EVPm2-3	EVP2-3	0.55	0.75		36	33	26	20	9
EVPm2-4	EVP2-4	0.75	1.0		48	45	35	26	11
EVPm2-5	EVP2-5	1.0	1.5		59	57	44	33	15
EVPm2-6	EVP2-6	1.0	1.5		69	65	52	37	18
EVPm2-7	EVP2-7	1.1	1.5		82	75	62	45	25
EVPm2-8	EVP2-8	1.5	2.0		94	87	72	52	28
EVPm2-9	EVP2-9	1.5	2.0		105	98	82	60	35
EVPm2-11	EVP2-11	1.8	2.5		130	119	98	69	37
-	EVP2-13	2.2	3.0		153	142	115	80	39

Model		Power (P2)		Q (m³/h)	0	1	2	3	4	5	6
Single-phase	Three-phase	kW	HP	Q (l/min)	0	16.7	33.3	50	66.7	83.3	100
EVPm4-2	EVP4-2	0.55	0.75	H (m)	24	23	22	21	18	15	10
EVPm4-3	EVP4-3	0.75	1.0		37	36	34	33	29	24	16
EVPm4-4	EVP4-4	1.0	1.5		47	46	45	41	36	28	20
EVPm4-5	EVP4-5	1.5	2.0		61	58	57	55	48	39	29
EVPm4-6	EVP4-6	1.5	2.0		74	72	69	66	57	47	36
-	EVP4-7	2.2	3.0		86	83	81	77	68	57	43
-	EVP4-8	2.2	3.0		98	95	92	86	76	63	47
-	EVP4-10	2.2	3.0		116	114	110	102	90	73	57
-	EVP4-12	3.0	4.0		145	142	140	131	115	97	75

Model		Power (P2)		Q (m³/h)	0	1	2	3	4	5	6	7	8	9	10
Single-phase	Three-phase	kW	HP	Q (l/min)	0	16.7	33.3	50	66.7	83.3	100	116.7	133.3	150	166.7
EVPm6-3	EVP6-3	1.1	1.5	H (m)	30	29.5	29	28.5	28	27	26	24.5	23	21	19
EVPm6-4	EVP6-4	1.5	2.0		40	38.5	37.5	37.3	37	36	34	33.5	32	30	27
-	EVP6-5	2.2	3.0		50	49	48.5	48.3	48	45	43	42	41	39	36
-	EVP6-6	2.2	3.0		58	56	54	53.5	53	52	51	48	45	41	40
-	EVP6-7	3.0	4.0		68	67	66.5	65	63.5	62	60	58	56	54	51
-	EVP6-8	3.0	4.0		78	75	73	72	71	70	68	65	62	59	55

Model		Power (P2)		Q (m³/h)	0	1	2	3	4.5	6	7.5	9	10.5
Single-phase	Three-phase	kW	HP	Q (l/min)	0	16.7	33.3	50	75	100	125	150	175
EVPm6H-3	EVP6H-3	1.1	1.5	H (m)	39	38	37	35	33	29	24	18	10
EVPm6H-4	EVP6H-4	1.5	2		52	51	49	47	44	39	32	25	14
EVPm6H-5	EVP6H-5	1.8	2.5		64	62	60	58	54	47	38	28	16
-	EVP6H-6	2.2	3		76	74	71	68	63	56	45	34	20
-	EVP6H-8	3.0	4		103	100	97	95	90	80	66	50	31
-	EVP6H-10	4.0	5.5		130	127	124	121	114	103	86	66	41

Model	Power (P2)		Q (m³/h)	0	2	4	6	8	10	12	14	16
Three-phase	kW	HP	Q (l/min)	0	33	67	100	133	167	200	233	267
EVP10H-3	3.0	4.0	H (m)	56	55	54	52	49	46	42	39	29
EVP10H-4	4.0	5.5		75	74	72	70	67	64	60	53	43
EVP10H-5	5.5	7.5		93	91	87	84	81	77	72	64	55
EVP10H-6	5.5	7.5		113	110	107	104	100	96	87	78	68
EVP10H-7	7.5	10		132	128	124	120	116	112	103	93	80
EVP10H-8	7.5	10		150	147	143	139	134	127	120	108	92

Dimension

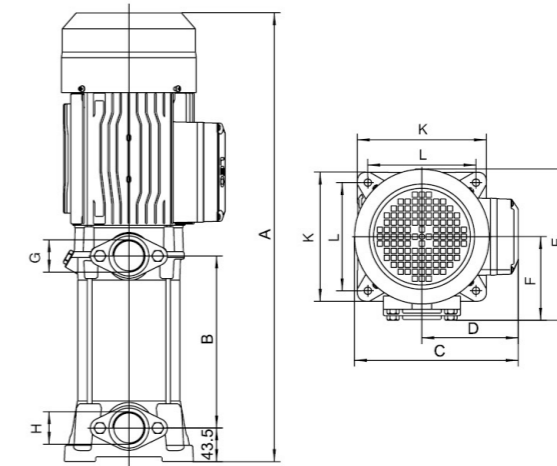

Model		Power (P2)	A	B	C	D	E	F	G	H	K	L
Single-phase	Three-phase	kW										
EVPm2-2	EVP2-2	0.37	382	122	193	110	202	114.5	G1	G1	166	140.5
EVPm2-3	EVP2-3	0.55	406	146	193	110	202	114.5	G1	G1	166	140.5
EVPm2-4	EVP2-4	0.75	430	170	193	110	202	114.5	G1	G1	166	140.5
EVPm2-5	EVP2-5	1.0	454	194	193	110	202	114.5	G1	G1	166	140.5
EVPm2-6	EVP2-6	1.0	478	218	193	110	202	114.5	G1	G1	166	140.5
EVPm2-7	EVP2-7	1.1	545	248.5	210	125	202	114.5	G1	G1	166	140.5
EVPm2-8	EVP2-8	1.5	569	272.5	210	125	202	114.5	G1	G1	166	140.5
EVPm2-9	EVP2-9	1.5	593	296.5	210	125	202	114.5	G1	G1	166	140.5
EVPm2-11	EVP2-11	1.8	641	344.5	210	125	202	114.5	G1	G1	166	140.5
-	EVP2-13	2.2	689	392.5	210	125	202	114.5	G1	G1	166	140.5
EVPm4-2	EVP4-2	0.55	382	122	193	110	202	114.5	G1	G1	166	140.5
EVPm4-3	EVP4-3	0.75	406	146	193	110	202	114.5	G1	G1	166	140.5
EVPm4-4	EVP4-4	1.0	430	170	193	110	202	114.5	G1	G1	166	140.5
EVPm4-5	EVP4-5	1.5	497	200.5	210	125	202	114.5	G1	G1	166	140.5
EVPm4-6	EVP4-6	1.5	521	224.5	210	125	202	114.5	G1	G1	166	140.5
-	EVP4-7	2.2	545	248.5	210	125	202	114.5	G1	G1	166	140.5
-	EVP4-8	2.2	569	272.5	210	125	202	114.5	G1	G1	166	140.5
-	EVP4-10	2.2	617	320.5	210	125	202	114.5	G1	G1	166	140.5
-	EVP4-12	3.0	731	374	240	141	218	121.5	G1	G1	166	140.5
EVPm6-3	EVP6-3	1.1	487	190	210	125	198.5	110	G1 1/4	G1 1/4	166	140.5
EVPm6-4	EVP6-4	1.5	524	227	210	125	198.5	110	G1 1/4	G1 1/4	166	140.5
-	EVP6-5	2.2	561	264	210	125	198.5	110	G1 1/4	G1 1/4	166	140.5
-	EVP6-6	2.2	598	301	210	125	198.5	110	G1 1/4	G1 1/4	166	140.5
-	EVP6-7	3.0	685	338	221	134	198.5	110	G1 1/4	G1 1/4	166	140.5
-	EVP6-8	3.0	722	375	221	134	198.5	110	G1 1/4	G1 1/4	166	140.5
EVPm6H-3	EVP6H-3	1.1	457	158.5	210	125	202	114.5	G1 1/4	G1 1/2	166	140.5
EVPm6H-4	EVP6H-4	1.5	483.5	185	210	125	202	114.5	G1 1/4	G1 1/2	166	140.5
EVPm6H-4	EVP6H-5	1.5	510	211.5	210	125	202	114.5	G1 1/4	G1 1/2	166	140.5
-	EVP6H-6	2.2	536.5	238	210	125	202	114.5	G1 1/4	G1 1/2	166	140.5
-	EVP6H-8	3.0	655	297.5	210	141	218	121.5	G1 1/4	G1 1/2	166	140.5
-	EVP6H-10	4.0	708	350.5	210	141	218	121.5	G1 1/4	G1 1/2	166	140.5
-	EVP10H-3	3.0	554.5	187	2410	141	227.5	127.5	G1 1/4	G1 1/2	192	164
-	EVP10H-4	4.0	577.5	220	240	141	227.5	127.5	G1 1/4	G1 1/2	192	164
-	EVP10H-5	5.5	647	253	262	152	237.5	128.5	G1 1/4	G1 1/2	192	164
-	EVP10H-6	5.5	680	286	262	152	237.5	128.5	G1 1/4	G1 1/2	192	164
-	EVP10H-7	7.5	713	319	262	152	237.5	128.5	G1 1/4	G1 1/2	192	164
-	EVP10H-8	7.5	746	352	262	152	237.5	128.5	G1 1/4	G1 1/2	192	164

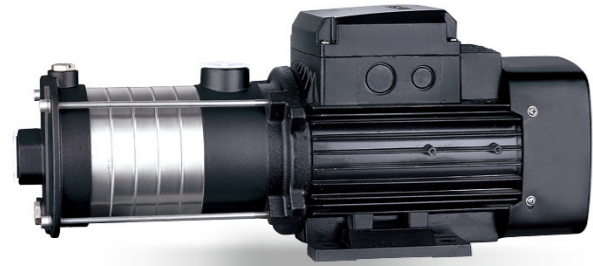

ECH

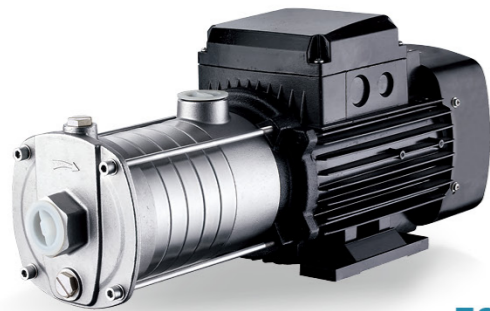

ECHS

Application

- It is applicable to household water supply, equipment support, pipeline pressurization, garden watering, vegetable greenhouse watering, fish farming and poultry raising, industrial and mining, water supply and drainage of enterprises and high-rise buildings, central air conditioner and centralized heating circulation system, etc

Pump

- AISI 304 shaft
- Max. liquid temperature: +85°C
- Altitude: up to 1000 m
- Max. suction: 8 m
- Max. inlet pressure: limited by max. operating pressure
- Max. operation pressure: 10 bar
- Liquid PH Value: 4-10

Motor

- IE2 motor (IE3 motor available on request)
- Motor with copper winding
- Built-in thermal protector for single phase motor
- Insulation class: F
- Protection class: P55
- Max ambient temperature: +40°C

Identification Codes

ECH (m) 2 - 20 (S)

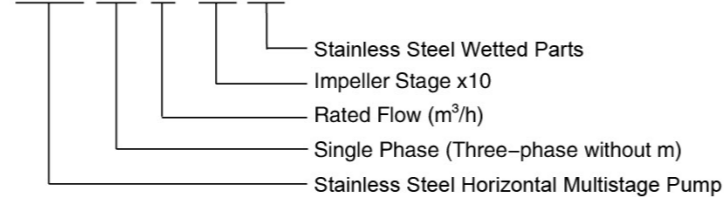

Application

- It is applicable to household water supply, equipment support, pipeline pressurization, garden watering, vegetable greenhouse watering, fish farming and poultry raising, industrial and mining, water supply and drainage of enterprises and high-rise buildings, central air conditioner and centralized heating circulation system, etc

Pump

- AISI 304 shaft
- Max. liquid temperature: +60°C
- Altitude: up to 1000 m
- Max. suction: 8 m
- Max. inlet pressure: limited by max. operating pressure
- Max. operation pressure: 10 bar
- Liquid PH Value: 6.5 - 8.5

Motor

- IE2 motor
- Motor with copper winding
- Built-in thermal protector for single phase motor
- Insulation class: F
- Protection class: IPX4
- Max. ambient temperature: +40°C

Identification Codes

ECH (m) 2 - 20 - F

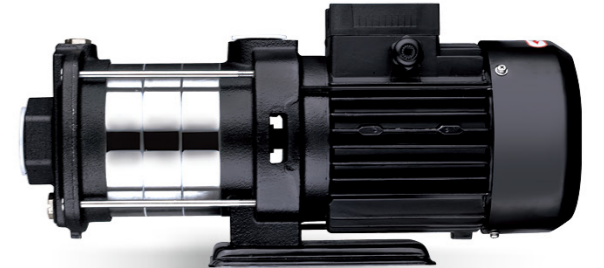
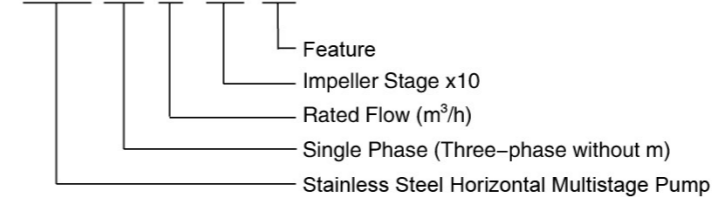

Materials Table

No.	Part	Material
1	Fan cover	08F
2	Fan	PP
3	Rear cover	ZL 102
4	Rotor	
5	Bearing	
6	Terminal box	ZL 102
7	Stator	
8	Front cover	Cast iron/AISI 304
9	Outlet body	Cast iron/AISI 304
10	Mechanical seal	Sic/Carbon
11	Positioning sleeve	AISI 304
12	Diffuser	AISI 304
13	Sleeve	AISI 304
14	Impeller	AISI 304
15	Pump body	Cast iron/AISI 304

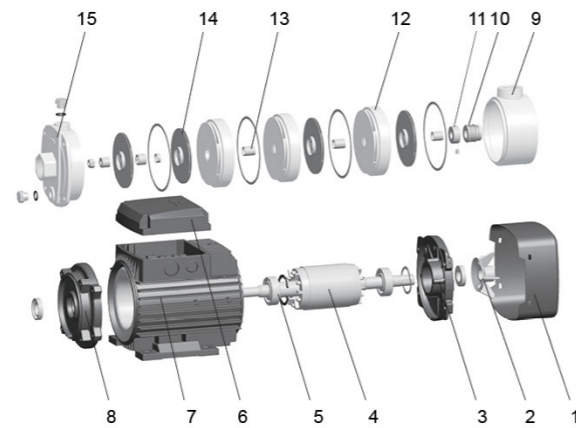

Materials Table

No.	Part	Material
1	Support	Cast iron
2	Base	Q235
3	Stator	ZL 102
4	Rear	ZL 102
5	Fan	PP-GF15
6	Fan cover	08F
7	Rotor	
8	O-ring	NBR
9	Terminal Box	PP-GF20
10	Mechanical seal	Sic/Carbon
11	O-ring	NBR
12	Sleeve	AISI 304
13	Pump body	HT200
14	Impeller	AISI 304
15	Diffuser	AISI 304

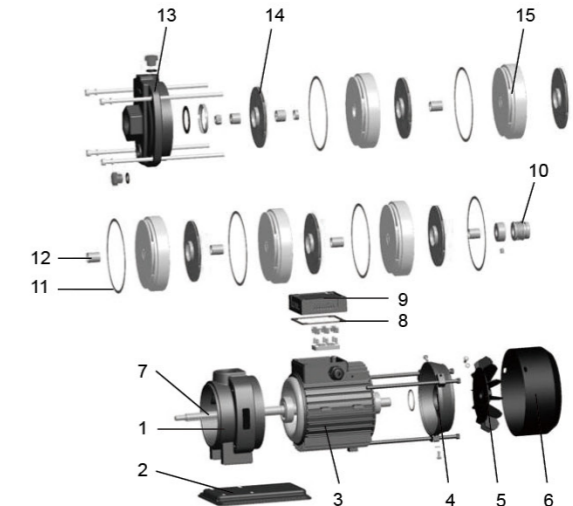

Scope of Performance - ECH

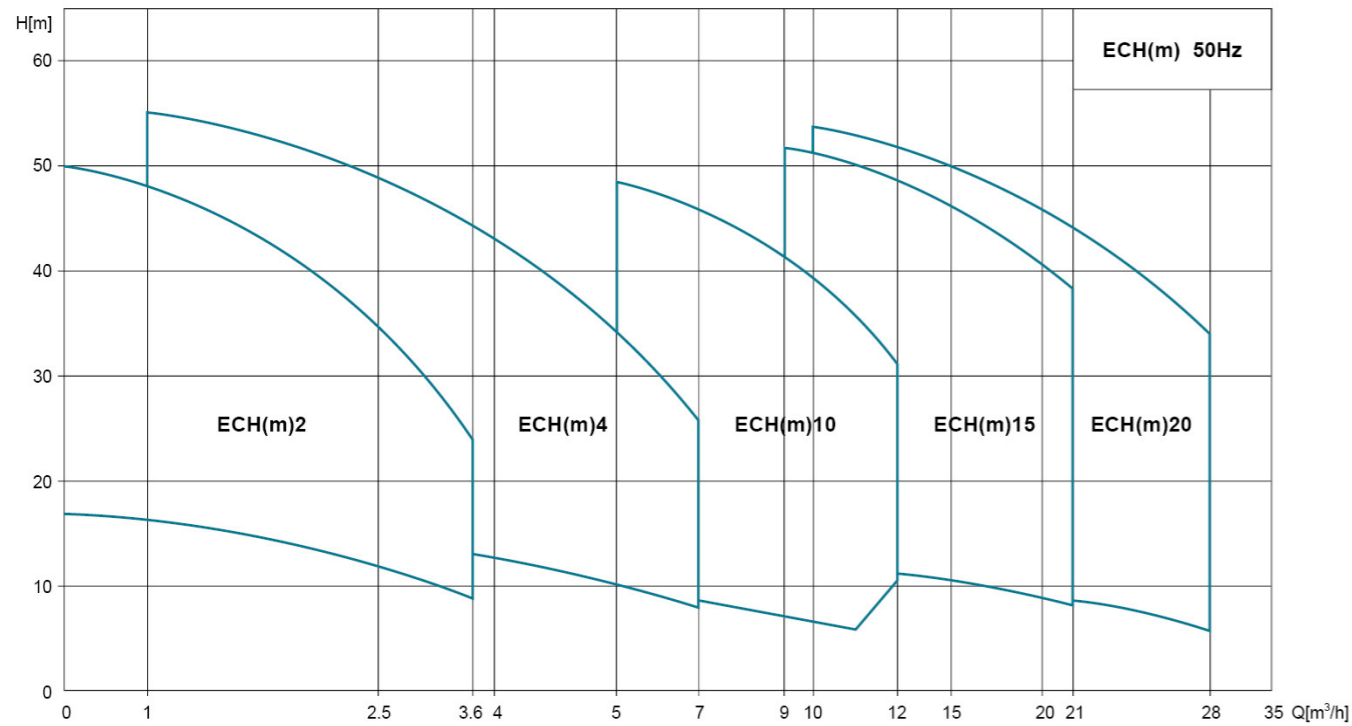

Scope of Performance - ECH-F

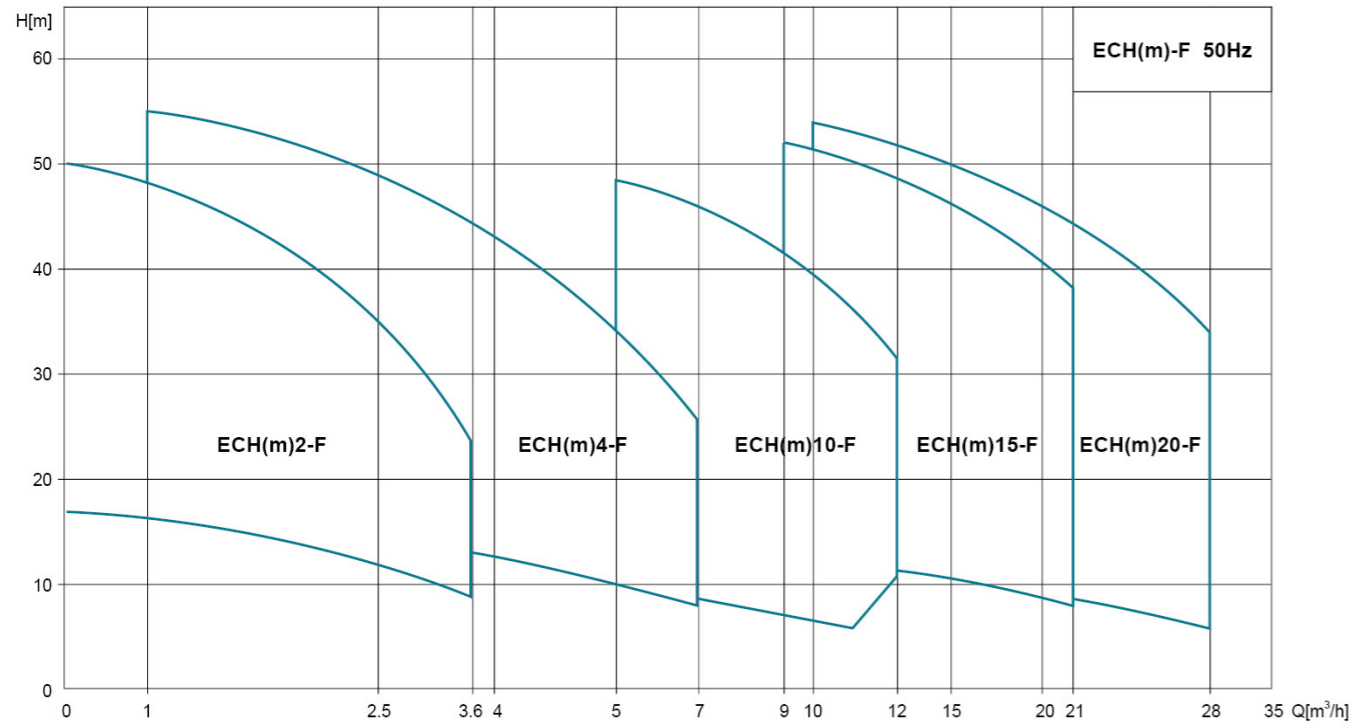

Hydraulic Performance Curves

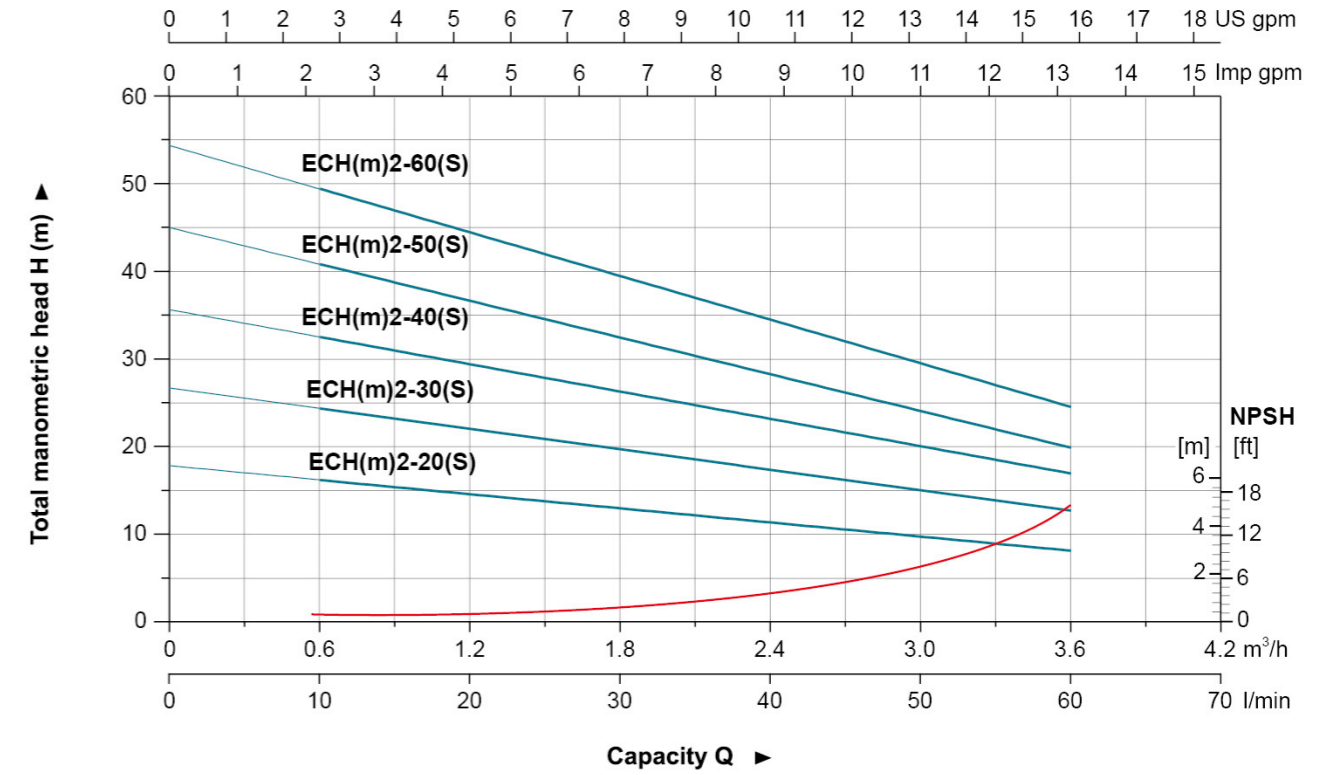

Technical Data

Model	Power		Q (m³/h) Q (l/min)	0.6	1.2	1.8	2.4	3.0	3.6
	kW	HP		H (m)	H (m)	H (m)	H (m)	H (m)	H (m)
ECH(m)2-20(S)	0.37	0.5	10	16	15	13	12	10	8
ECH(m)2-30(S)	0.37	0.5	20	24	22	20	18	16	12
ECH(m)2-40(S)	0.55	0.75	30	33	30	26	24	21	16
ECH(m)2-50(S)	0.55	0.75	40	40	37	33	30	24	19
ECH(m)2-60(S)	0.75	1.0	60	50	45	40	36	30	23

Dimension

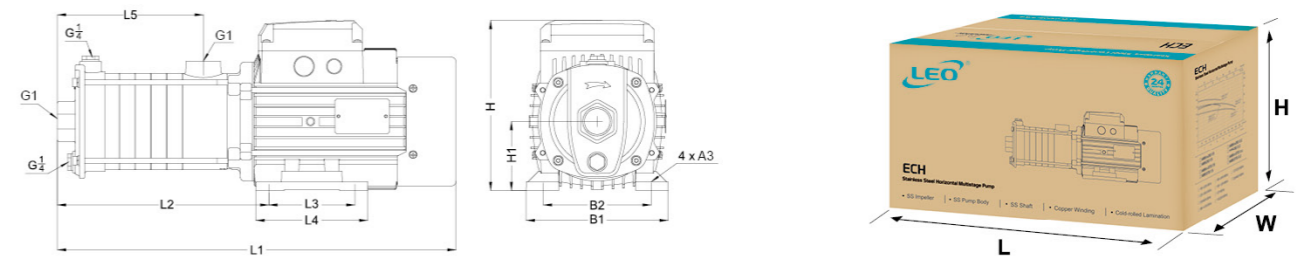

Model	L1	L2	L3	L4	L5	B1	B2	H	H1	A3	GW (Kgs)	L x W x H (mm)	Quantity (PCS/20' TEU)
ECH(m)2-20(S)	344.5	165.5	90	110	98.5	137	109	176.5	71	Φ7	11.5	420x215x243	1215
ECH(m)2-30(S)	362.5	183.5	90	110	116.5	137	109	176.5	71	Φ7	11.8	420x215x243	1215
ECH(m)2-40(S)	380.5	201.5	90	100	134.5	137	109	176.5	71	Φ7	13.2	420x215x243	1215
ECH(m)2-50(S)	399.5	220.5	90	110	153.5	137	109	176.5	71	Φ7	13.7	455x215x243	1170
ECH(m)2-60(S)	417.5	238.5	90	110	171.5	137	109	176.5	71	Φ7	14.6	455x215x243	1170

Hydraulic Performance Curves

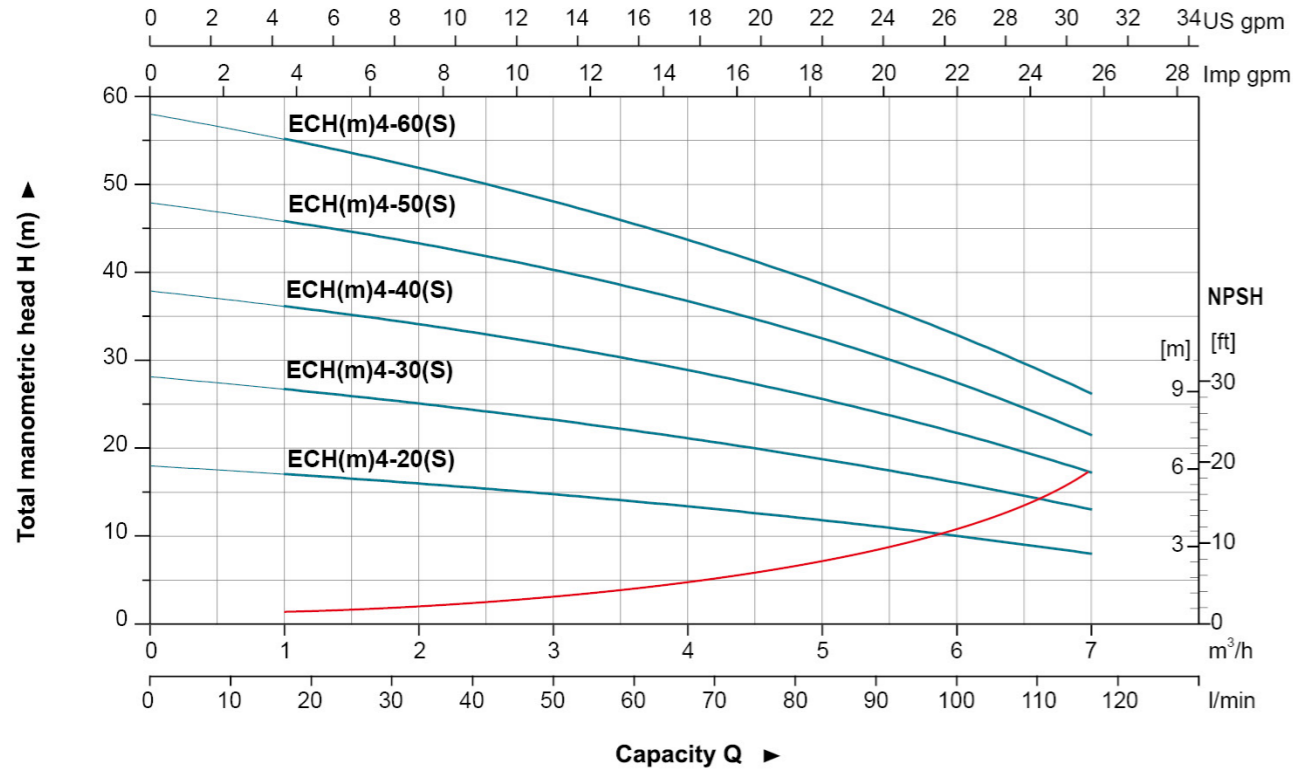

Technical Data

Model	Power		Q(m³/h) Q(l/min)	1	2	3	4	5	6	7
	kW	HP		H (m)	H (m)	H (m)	H (m)	H (m)	H (m)	H (m)
ECH(m)4-20(S)	0.55	0.75	17	17	16	15	13	12	10	8
ECH(m)4-30(S)	0.55	0.75	27	27	25	23	21	19	16	13
ECH(m)4-40(S)	0.75	1.0	36	36	34	32	28	26	22	17
ECH(m)4-50(S)	1.1	1.5	46	46	43	40	36	33	28	21
ECH(m)4-60(S)	1.1	1.5	55	55	52	48	43	39	33	26

Dimension

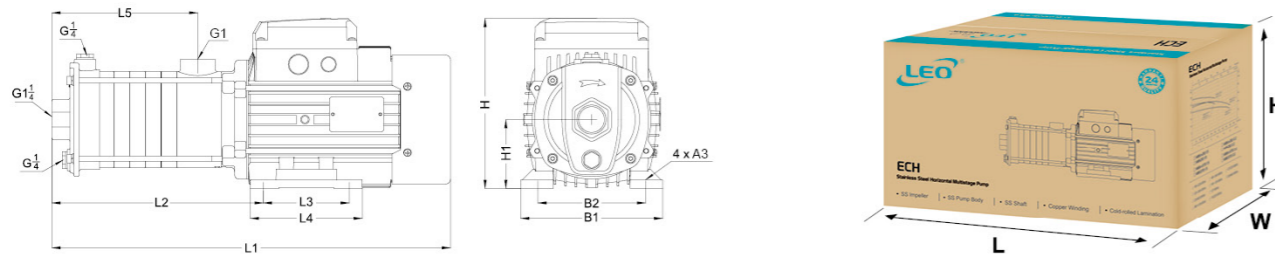

Model	L1	L2	L3	L4	L5	B1	B2	H	H1	A3	GW (Kgs)	L x W x H (mm)	Quantity (PCS/20*TEU)
ECH(m)4-20(S)	354	175.5	90	110	108.5	137	109	176.5	71	Φ7	13.1	420x215x243	1215
ECH(m)4-30(S)	381.5	203	90	110	136	137	109	176.5	71	Φ7	13.6	420x215x243	1215
ECH(m)4-40(S)	408.5	230	90	110	163	137	109	176.5	71	Φ7	14.7	455x215x243	1170
ECH(m)4-50(S)	484	266	100	130	190	165	125	204.5	80	Φ10	21.5	548x235x268	800
ECH(m)4-60(S)	511.5	293.5	100	130	217.5	165	125	204.5	80	Φ10	22	548x235x268	800

Hydraulic Performance Curves

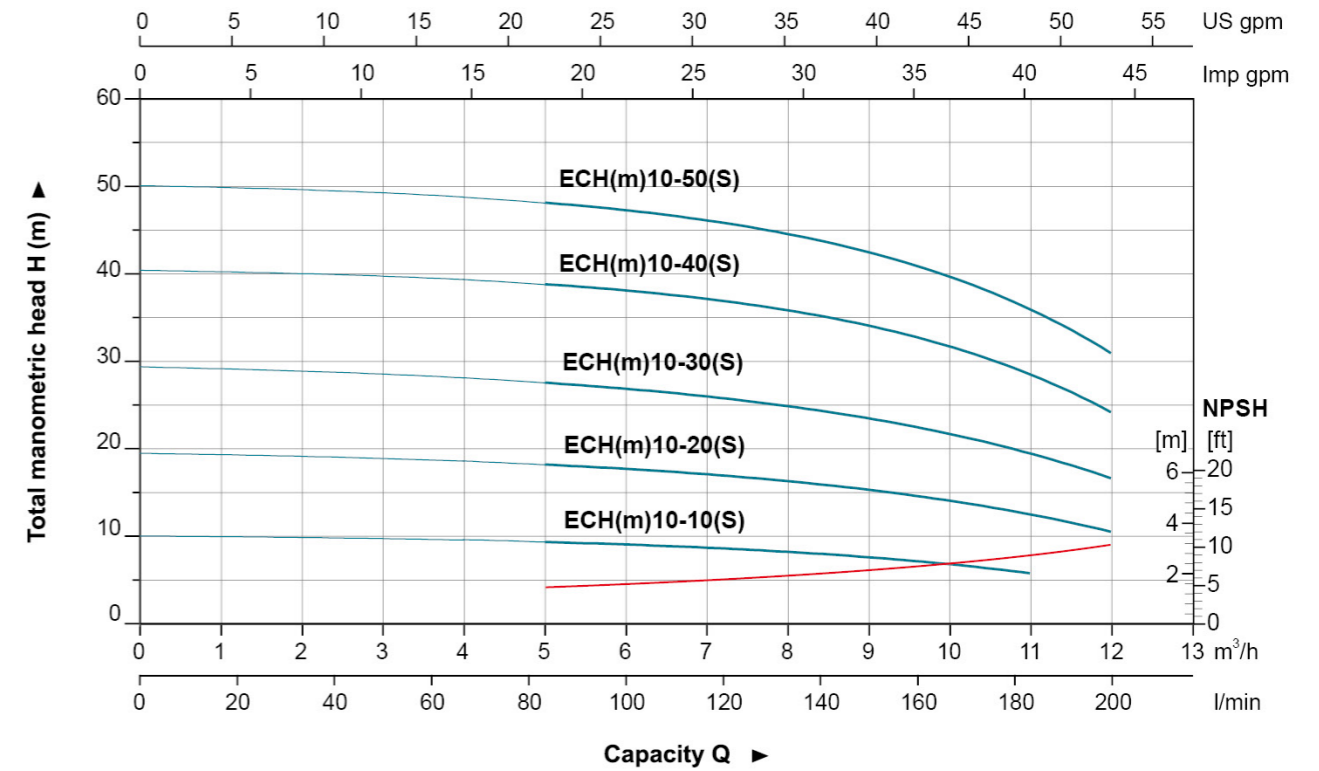

Technical Data

Model	Power		Q(m³/h) Q(l/min)	6	7	8	9	10	11	12
	kW	HP		H (m)	H (m)	H (m)	H (m)	H (m)	H (m)	H (m)
ECH(m)10-10(S)	0.75	1.0	9.1	9.1	8.7	8.2	7.7	6.8	5.8	-
ECH(m)10-20(S)	0.75	1.0	17.9	17.9	17.1	16.3	15.3	14	12.5	10.6
ECH(m)10-30(S)	1.1	1.5	27.1	27.1	26.3	24.9	23.4	21.4	19.3	16.9
ECH(m)10-40(S)	1.5	2.0	38.6	38.6	37.6	35.9	33.9	31.2	28.2	24.6
ECH(m)10-50(S)	2.2	3.0	47.8	47.8	46.4	44.4	42.2	39.5	35.9	31.1

Dimension

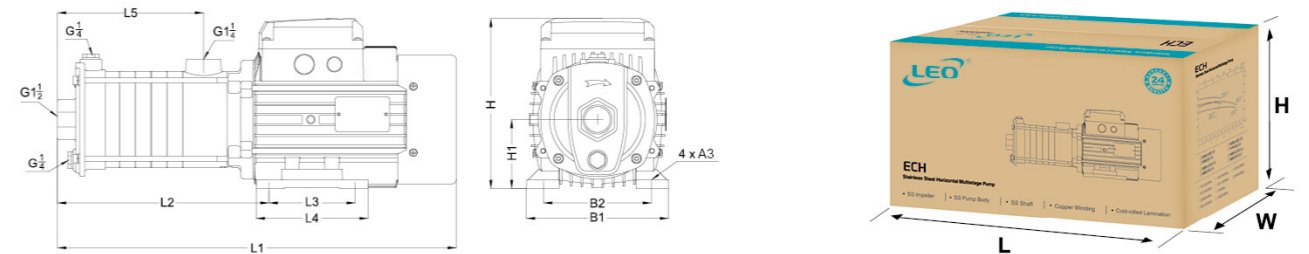

Model	L1	L2	L3	L4	L5	B1	B2	H	H1	A3	GW (Kgs)	L x W x H (mm)	Quantity (PCS/20*TEU)
ECH(m)10-10(S)	430	212	100	130	121	165	125	204.5	80	Φ10	20.7	503x235x268	856
ECH(m)10-20(S)	430	212	100	130	121	165	125	204.5	80	Φ10	20.8	503x235x268	856
ECH(m)10-30(S)	460.5	242.5	100	130	151.5	165	125	504.5	80	Φ10	21.9	503x235x268	856
ECH(m)10-40(S)	549.5	261.5	125	150	182	180	140	217.5	90	Φ10	28.2	618x245x283	653
ECH(m)10-50(S)	579.5	291.5	125	150	212	180	140	217.5	90	Φ10	30.6	618x245x283	653

Hydraulic Performance Curves

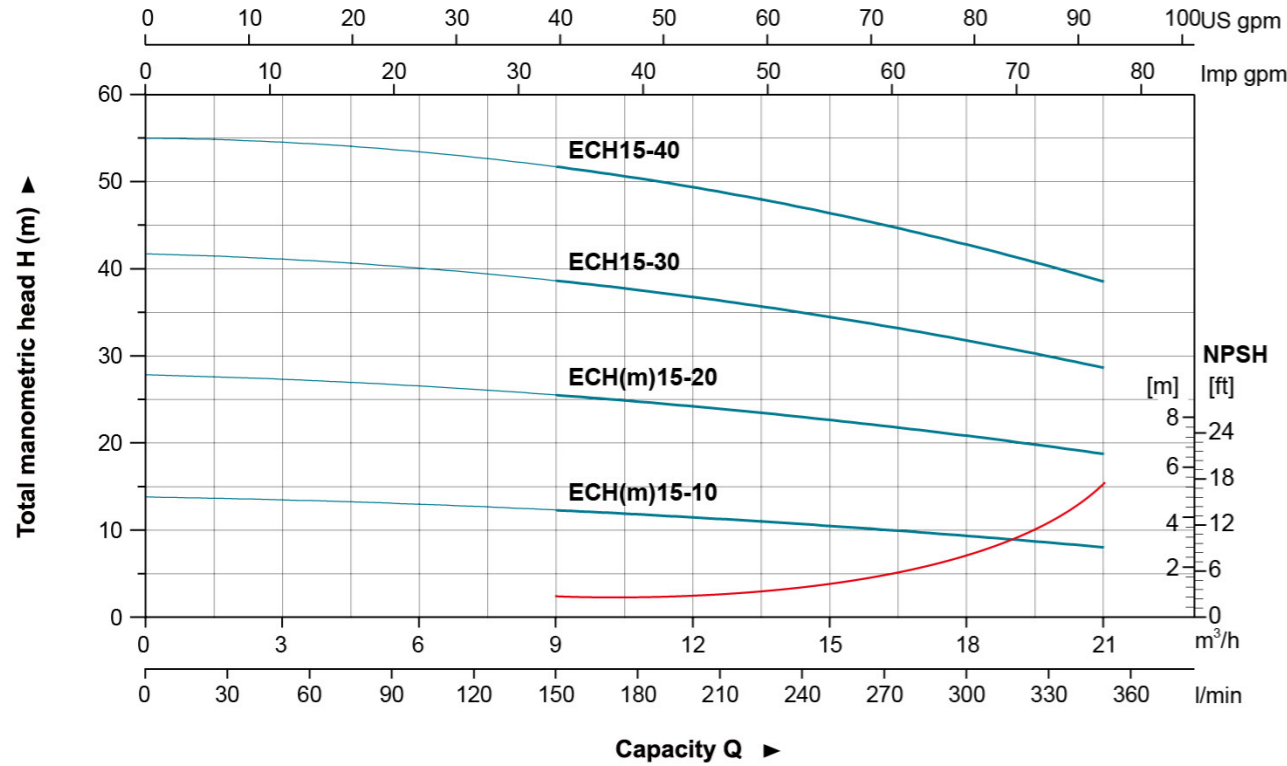

Technical Data

Model	Power		Q(m³/h) Q(l/min)	9	12	15	18	21
	kW	HP		H (m)	H (m)	H (m)	H (m)	H (m)
ECH(m)15-10	1.1	1.5	150	12.4	11.6	10.6	9.4	8.2
ECH(m)15-20	2.2	3	210	25.6	24.1	22.7	21.1	18.8
ECH15-30	3.0	4	270	38.7	36.9	34.9	31.9	28.5
ECH15-40	4.0	5.5	360	51.8	49.7	46.8	42.9	38.3

Dimension

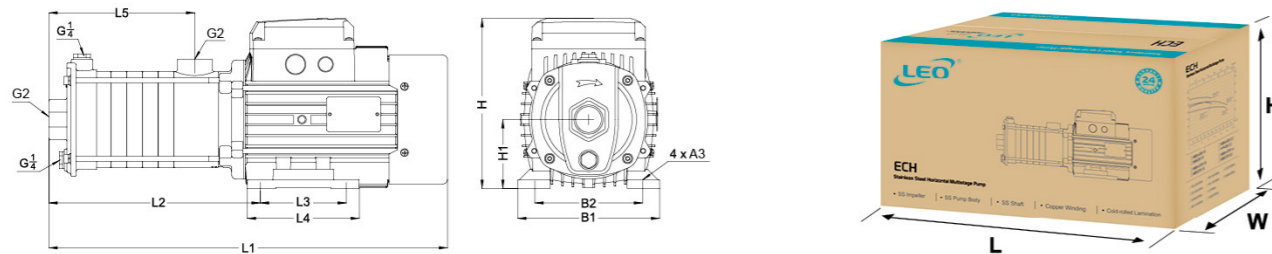

Model	L1	L2	L3	L4	L5	B1	B2	H	H1	A3	GW (Kgs)	L x W x H (mm)	Quantity (PCS/20 TEU)
ECH(m)15-10	451	233.5	100	130	139.5	165	125	204.5	80	Φ10	22.7	503x235x268	856
ECH(m)15-20	510	222	125	150	139.5	180	140	217.5	90	Φ10	30.3	557x245x283	659
ECH15-30	560	272	125	150	189.5	180	140	247.5	90	Φ10	32.2	618x245x283	620
ECH15-40	616	336.5	140	180	230	205	160	224.5	100	Φ12	39.6	687x245x290	504

Hydraulic Performance Curves

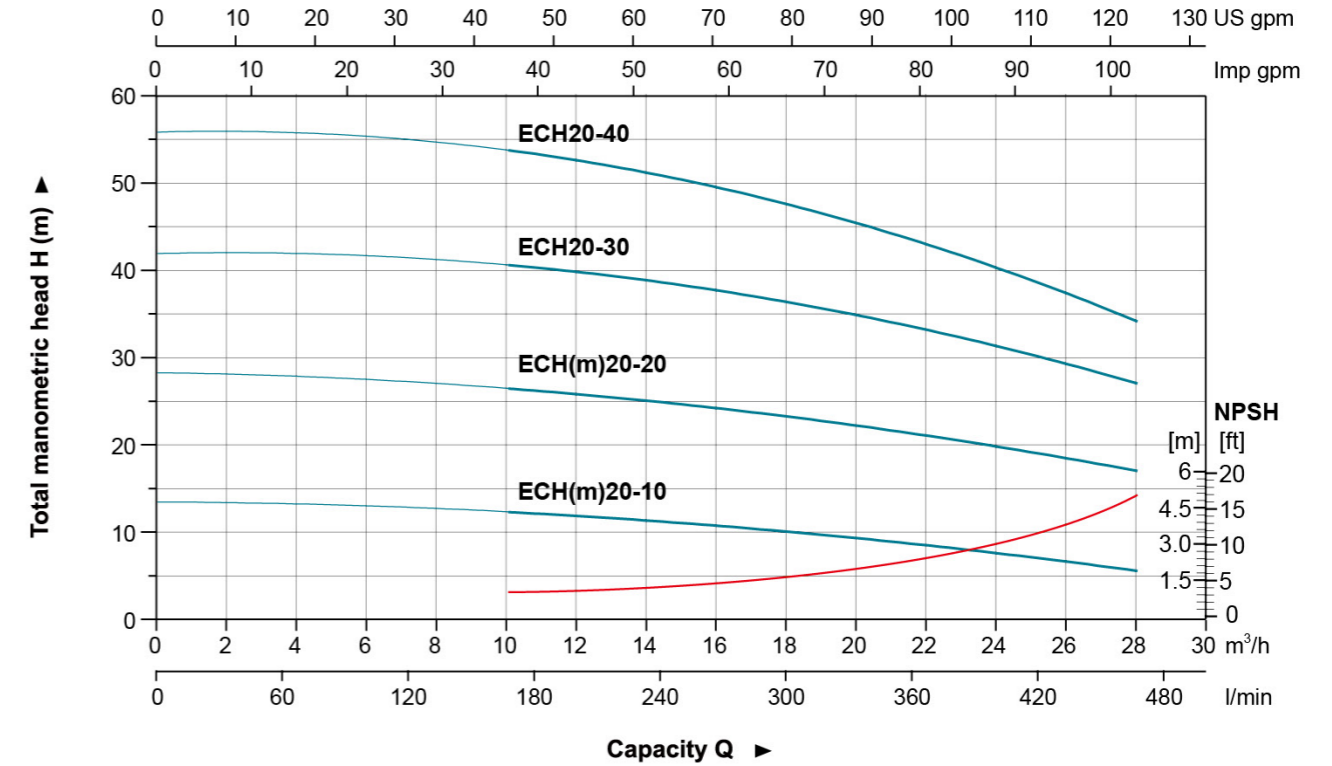

Technical Data

Model	Power		Q(m³/h) Q(l/min)	12	16	20	24	28
	kW	HP		H (m)	H (m)	H (m)	H (m)	H (m)
ECH(m)20-10	1.1	1.5	180	12.1	10.8	9.5	7.8	5.7
ECH(m)20-20	2.2	3	240	26.1	24.4	22.4	19.8	17.2
ECH20-30	4.0	5.5	300	39.9	38.0	35.5	31.4	26.9
ECH20-40	4.0	5.5	360	52.7	50.1	45.9	40.3	34.0

Dimension

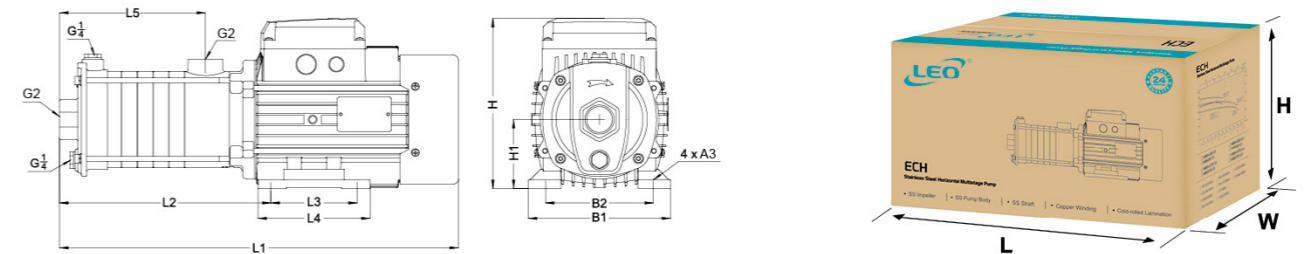

Model	L1	L2	L3	L4	L5	B1	B2	H	H1	A3	GW (Kgs)	L x W x H (mm)	Quantity (PCS/20 TEU)
ECH(m)20-10	451	233.5	100	130	139.5	165	125	204.5	80	Φ10	22.7	503x235x268	856
ECH(m)20-20	510	222	125	150	139.5	180	140	217.5	90	Φ10	30.3	557x245x283	659
ECH20-30	570.5	291	140	180	184.5	205	160	224.5	100	Φ12	38.9	687x245x290	513
ECH20-40	616	336.5	140	180	230	205	160	224.5	100	Φ12	39.4	687x245x290	504

Hydraulic Performance Curves

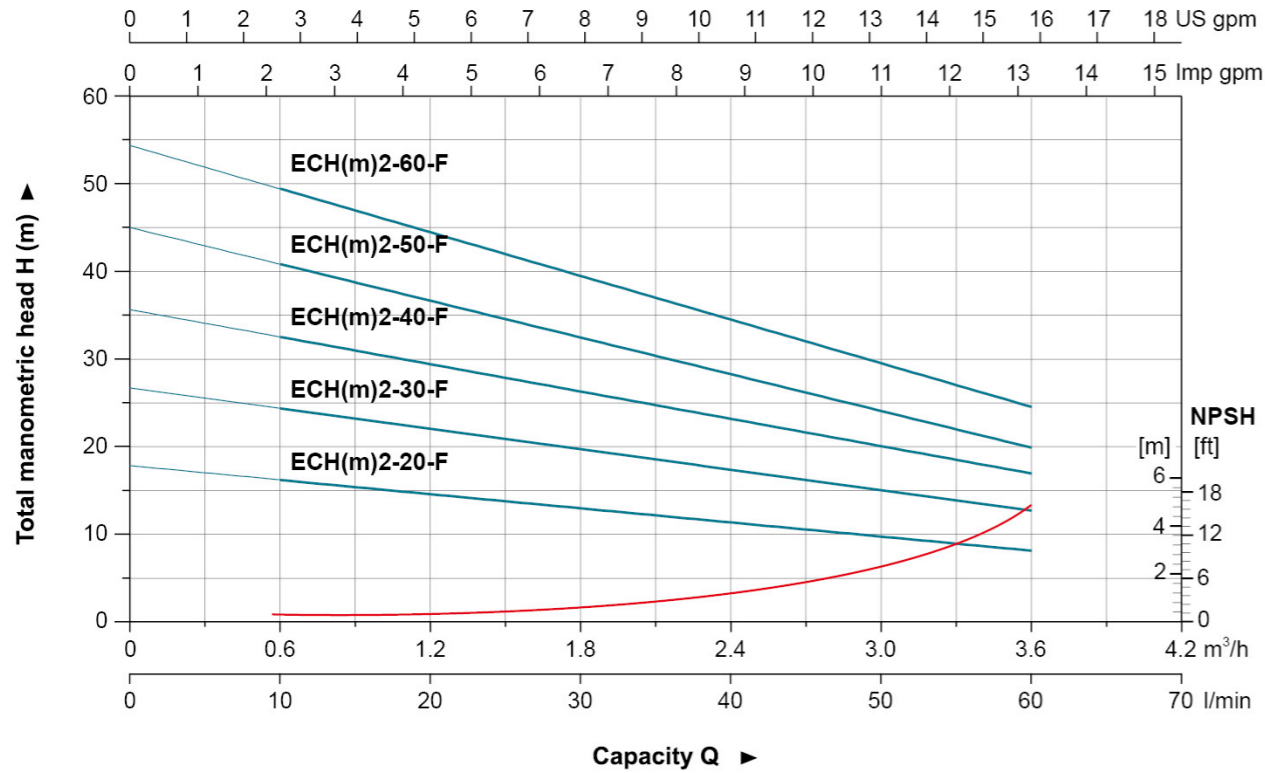

Technical Data

Model	Power		Q (m³/h) Q (l/min)	H (m)						
	kW	HP		0	0.6	1.2	1.8	2.4	3.0	3.6
ECH(m)2-20-F	0.37	0.5	0 / 10	18	16	15	13	12	10	8
ECH(m)2-30-F	0.37	0.5	10 / 20	27	24	22	20	18	16	12
ECH(m)2-40-F	0.55	0.75	20 / 40	35	33	30	26	24	21	16
ECH(m)2-50-F	0.55	0.75	30 / 60	45	40	37	33	30	24	19
ECH(m)2-60-F	0.75	1.0	4.2 / 70	53	50	45	40	36	30	23

Dimension

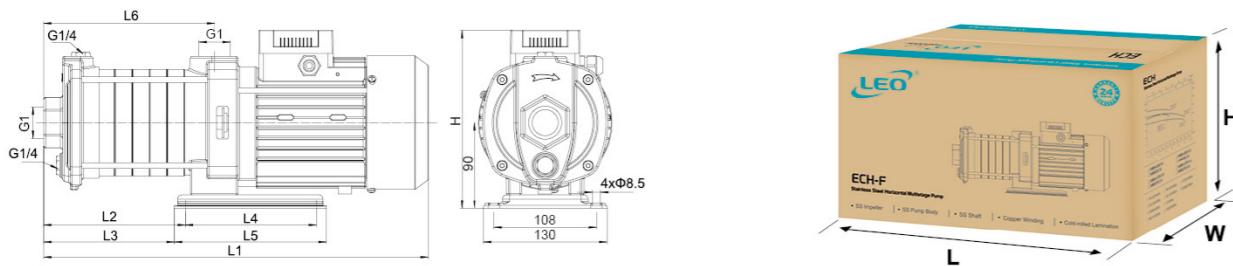

Model	L1	L2	L3	L4	L5	L6	H		GW (Kgs)	L x W x H (mm)	Quantity (PCS/20'TEU)
							1~	3~			
ECH(m)2-20-F	333	75	64	138	160	103.5	197.5	187	12.3	400x205x240	1386
ECH(m)2-30-F	352	93.5	82.5	138	160	122	197.5	187	12.6	400x205x240	1260
ECH(m)2-40-F	370	112	101	138	160	140.5	197.5	187	13.3	400x205x240	1386
ECH(m)2-50-F	389	130.5	119.5	138	160	159	197.5	187	13.8	400x205x240	1260
ECH(m)2-60-F	407	149	138	138	160	177.5	197.5	187	14.7	400x205x240	1161

Hydraulic Performance Curves

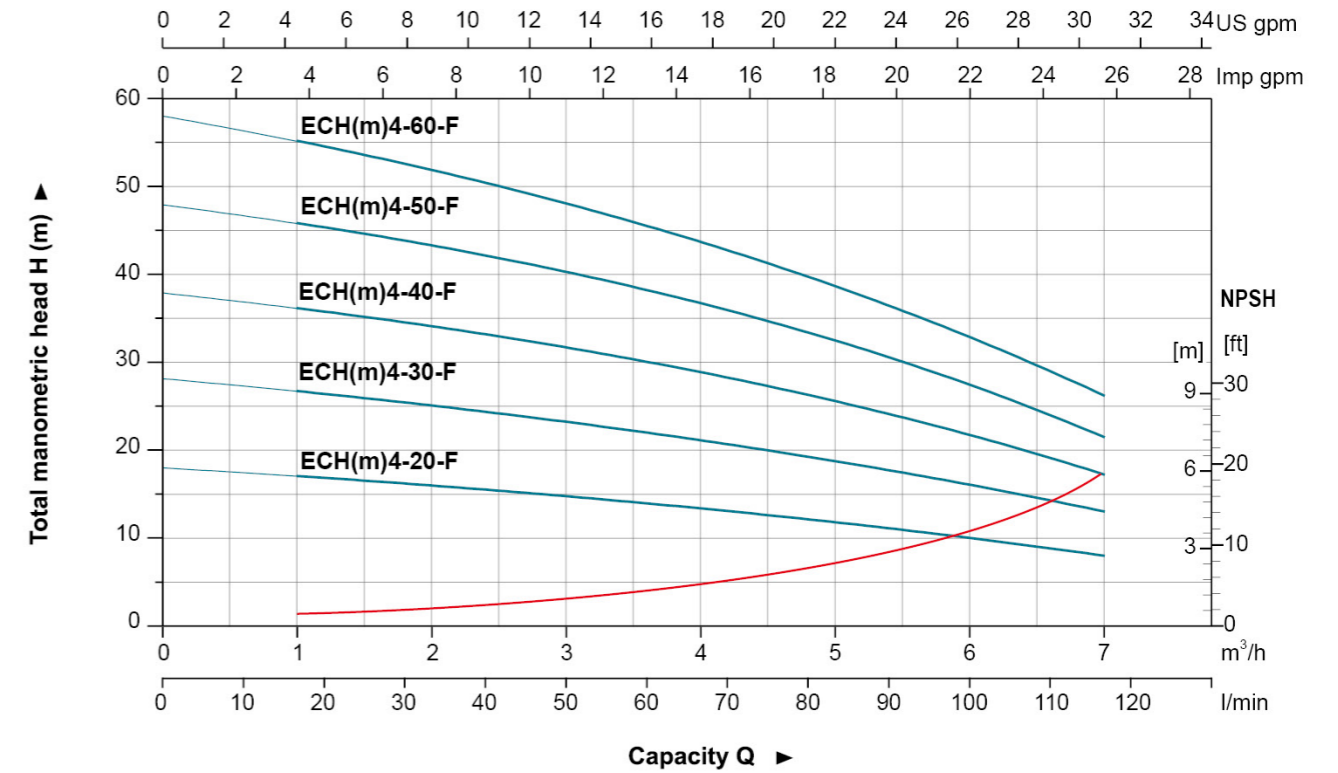

Technical Data

Model	Power		Q (m³/h) Q (l/min)	H (m)							
	kW	HP		0	1	2	3	4	5	6	7
ECH(m)4-20-F	0.55	0.75	0 / 10	18	17	16	15	13	12	10	8
ECH(m)4-30-F	0.55	0.75	10 / 20	28	27	25	23	21	19	16	13
ECH(m)4-40-F	0.75	1.0	20 / 40	38	36	34	32	28	26	22	17
ECH(m)4-50-F	1.1	1.5	30 / 60	48	46	43	40	36	33	28	21
ECH(m)4-60-F	1.1	1.5	4.2 / 70	58	55	52	48	43	39	33	26

Dimension

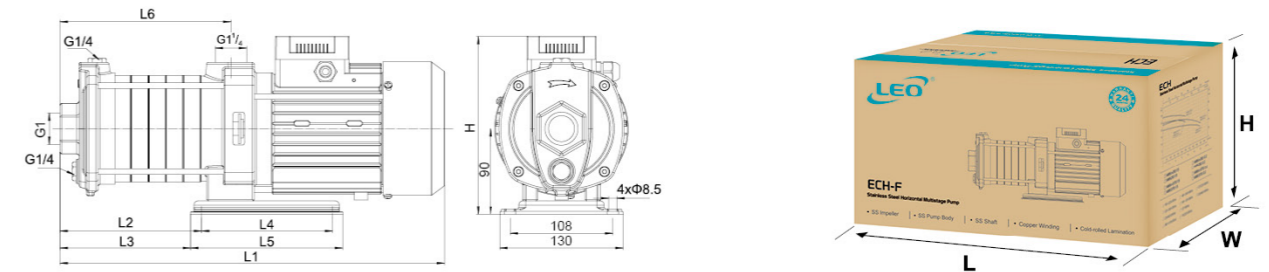

Model	L1	L2	L3	L4	L5	L6	H		GW (Kgs)	L x W x H (mm)	Quantity (PCS/20'TEU)
							1~	3~			
ECH(m)4-20-F	342	85.5	74.5	138	160	114	197.5	187	12.8	400x205x240	1386
ECH(m)4-30-F	370	113	102	138	160	141.5	197.5	187	13	400x205x240	1386
ECH(m)4-40-F	398	140.5	129.5	138	160	169	197.5	187	14.9	455x205x240	1260
ECH(m)4-50-F	426	168	157	138	160	196.5	197.5	187	15.7	455x205x240	1260
ECH(m)4-60-F	453	195.5	184.5	138	160	224	197.5	187	15.9	485x205x240	1161

Hydraulic Performance Curves

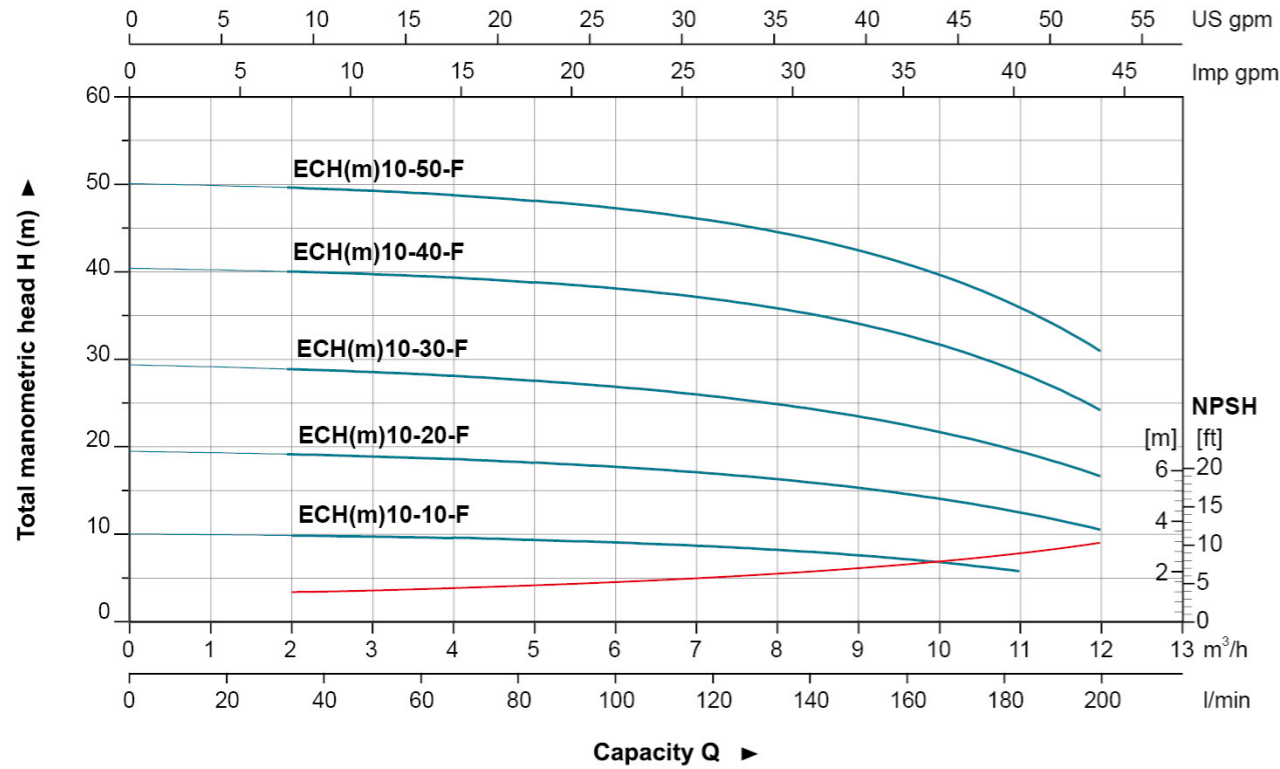

Technical Data

Model	Power		Q(m³/h) Q(l/min)	H (m)											
	kW	HP		0	2	4	6	7	8	9	10	11	12		
ECH(m)10-10-F	0.75	1.0	3	10.1	9.8	9.6	9.1	8.7	8.2	7.7	6.8	5.8	-		
ECH(m)10-20-F	0.75	1.0	6	19.5	19	18.7	17.9	17.1	16.3	15.3	14	12.5	10.6		
ECH(m)10-30-F	1.1	1.5	9	29.3	28.6	28.3	27.1	26.3	24.9	23.4	21.4	19.3	16.9		
ECH(m)10-40-F	1.5	2.0	12	38.1	39.6	39.8	38.6	37.6	35.9	33.9	31.2	28.2	24.6		
ECH(m)10-50-F	2.2	3.0	15	49.9	49.2	49.1	47.8	46.4	44.4	42.2	39.5	35.9	31.1		

Dimension

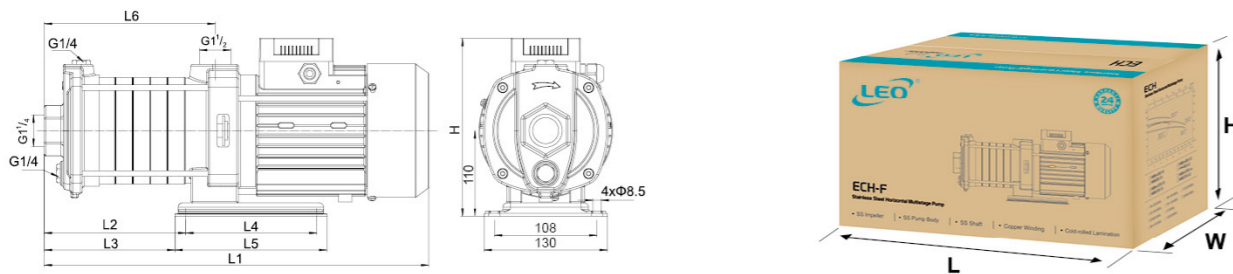

Model	L1	L2	L3	L4	L5	L6	H		GW (Kgs)	L x W x H (mm)	Quantity (PCS/20'TEU)
							1~	3~			
ECH(m)10-10-F	398	122	111	138	160	120	232.5	226	21.5	435x275x310	896
ECH(m)10-20-F	398	122	111	138	160	120	232.5	226	21.9	435x275x310	896
ECH(m)10-30-F	428	152	141	138	160	150	232.5	226	24.3	465x275x310	756
ECH(m)10-40-F	530	194	183	138	160	187	236	230	26.1	575x275x310	686
ECH(m)10-50-F	560	224	213	138	160	217	242	230	30.4	605x275x310	637

Hydraulic Performance Curves

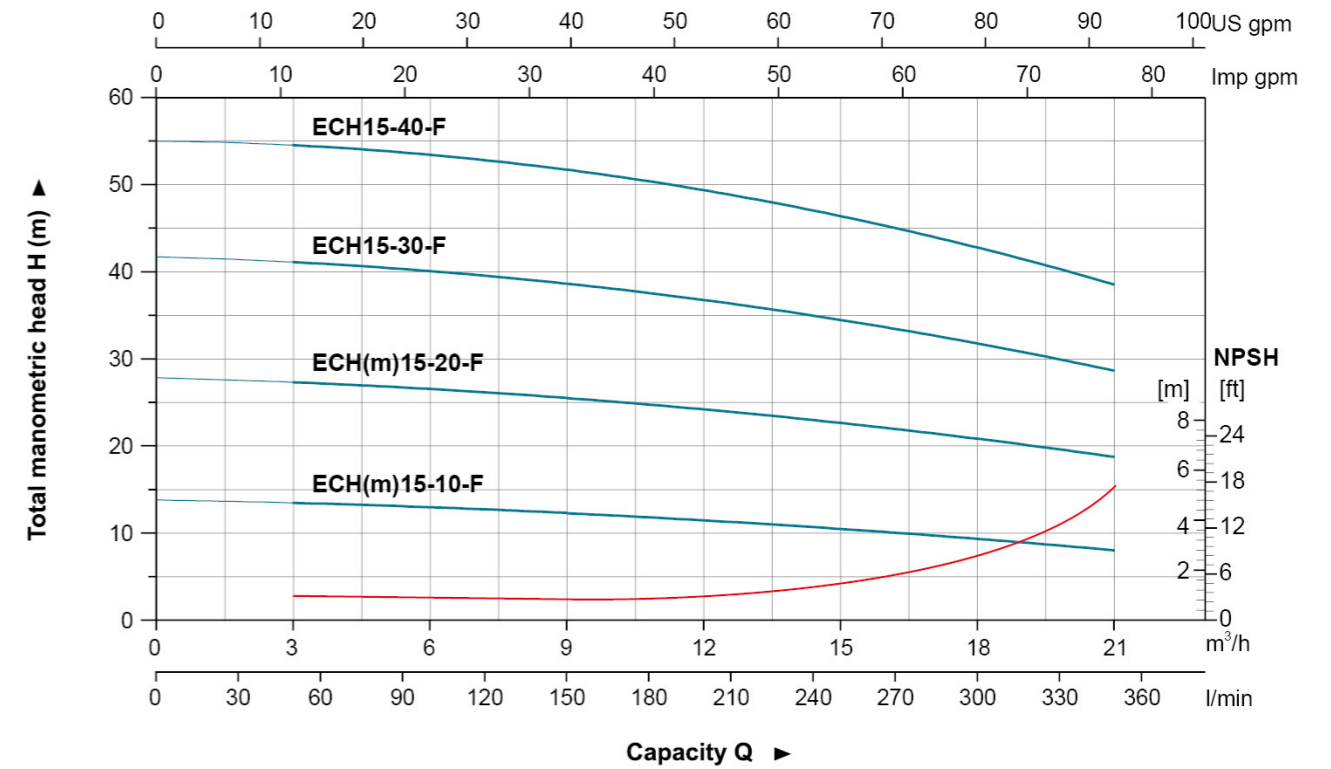

Technical Data

Model	Power		Q(m³/h) Q(l/min)	H (m)									
	kW	HP		0	3	6	9	12	15	18	21		
ECH(m)15-10-F	1.1	1.5	3	13.9	13.5	13.1	12.4	11.6	10.6	9.4	8.2		
ECH(m)15-20-F	2.2	3	6	27.8	27.5	26.7	25.6	24.1	22.7	21.1	18.8		
ECH15-30-F	3.0	4	9	42.1	40.9	39.8	38.7	36.9	34.9	31.9	28.5		
ECH15-40-F	4.0	5.0	12	55.5	54.3	52.8	51.8	49.7	46.8	42.9	38.3		

Dimension

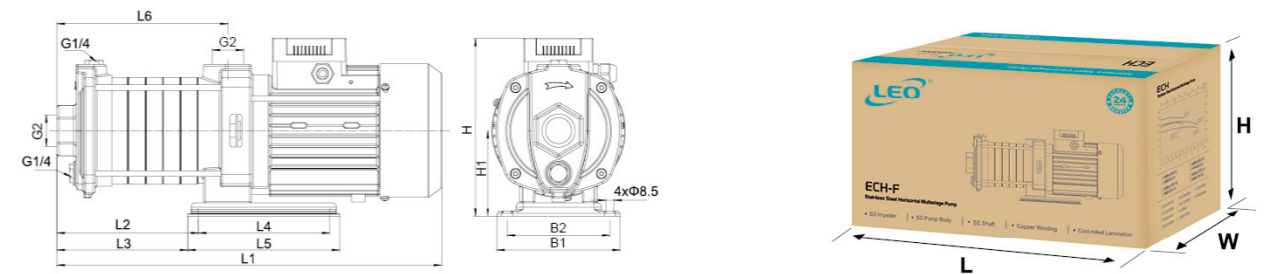

Model	L1	L2	L3	L4	L5	L6	B1	B2	H		H1	GW (Kgs)	L x W x H (mm)	Quantity (PCS/20'TEU)
									1~	3~				
ECH(m)15-10-F	419	142	131	138	160	142	130	108	232.5	226	110	23	465x275x310	756
ECH(m)15-20-F	485	149	138	138	160	142	130	108	242	230	110	29.2	530x275x310	696
ECH15-30-F	546	192	190	190	230	185	180	140	-	250	120	34.5	590x275x310	539
ECH15-40-F	591	237	217	190	230	230	180	140	-	250	120	46.5	635x275x310	430

Hydraulic Performance Curves

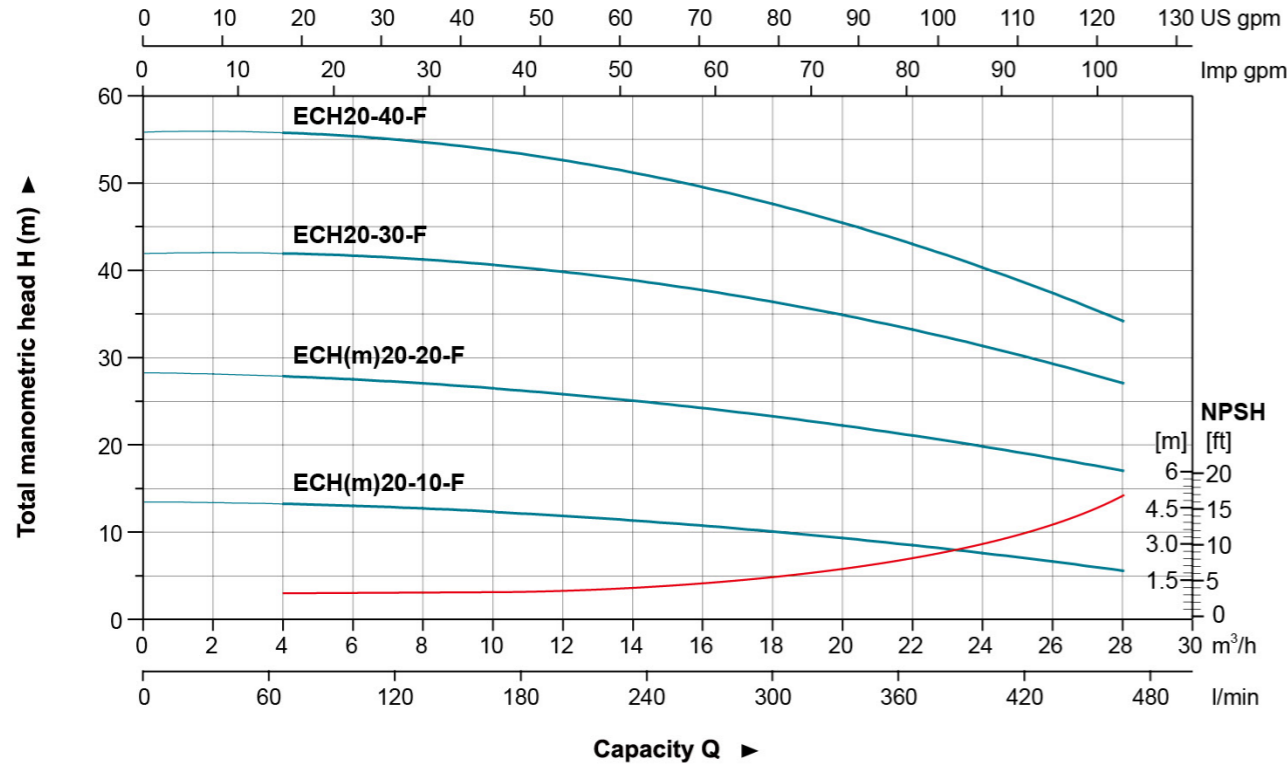

Technical Data

Model	Power		Q(m³/h) Q(l/min)	H (m)							
	kW	HP		0	4	8	12	16	20	24	28
ECH(m)20-10-F	1.1	1.5	0, 67	13.6	13.3	12.8	12.1	10.8	9.5	7.8	5.7
ECH(m)20-20-F	2.2	3	0, 133	28.5	27.8	27.0	26.1	24.4	22.4	19.8	17.2
ECH20-30-F	4.0	5.0	0, 200	42.5	41.6	40.9	39.9	38.0	35.5	31.4	26.9
ECH20-40-F	4.0	5.0	0, 267	56.6	55.2	54.2	52.7	50.1	45.9	40.3	34.0

Dimension

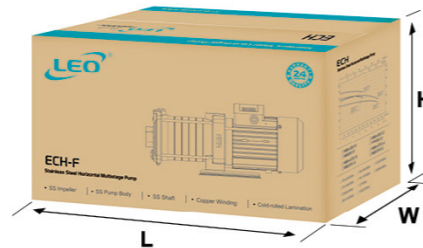
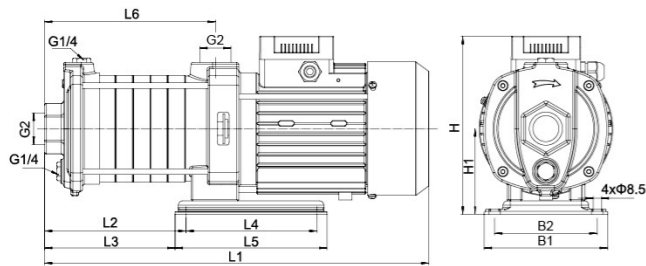

Model	L1	L2	L3	L4	L5	L6	B1	B2	H		H1	GW (Kgs)	L x W x H (mm)	Quantity (PCS/20 TEU)
									1~	3~				
ECH(m)20-10-F	419	142	131	138	160	142	130	108	232.5	226	110	23	465x275x310	756
ECH(m)20-20-F	485	149	138	138	160	142	130	108	242	230	110	29.2	530x275x310	696
ECH20-30-F	546	192	190	190	230	185	180	140	-	250	120	37.3	590x275x310	536
ECH20-40-F	591	237	217	190	230	230	180	140	-	250	120	46.5	635x275x310	430

Application

- It is applicable to household water supply, equipment support, pipeline pressurization, garden watering, vegetable greenhouse watering, fish farming and poultry raising, industrial and mining, water supply and drainage of enterprises and high-rise buildings, central air conditioner and centralized heating circulation system, etc

Pump

- AISI 304 shaft
- Max. liquid temperature: +40°C
- Altitude: up to 1000 m
- Max. suction: 8 m
- Max. inlet pressure: limited by max. operating pressure
- Max. operation pressure: 8 bar
- Liquid PH Value: 6.5 - 8.5

Motor

- IE2 Motor (IE3 motor available on request)
- Motor with copper winding
- Built-in thermal protector for single phase motor
- Insulation class: F
- Protection class: IP55
- Max. ambient temperature: +40°C

Identification Codes

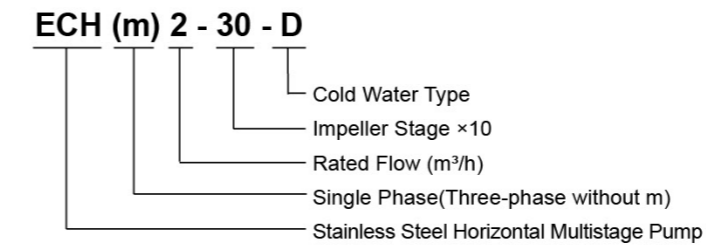

Materials Table

No.	Part	Material
1	Pump body	Cast iron
2	Shaft end sleeve	AISI304
3	Snap ring	PTFE
4	Diffuser	AISI304
5	Impeller	AISI304
6	Sleeve	AISI304
7	Mechanical seal	Sic/Carbon
8	Fan cover	08F
9	Fan	PP
10	Rear cover	ZL102
11	Bearing	
12	Stator	
13	Rotor	
14	Outlet body	Cast iron
15	Collar	PTFE
16	Support	PTFE

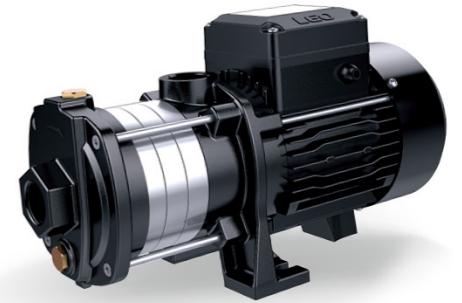
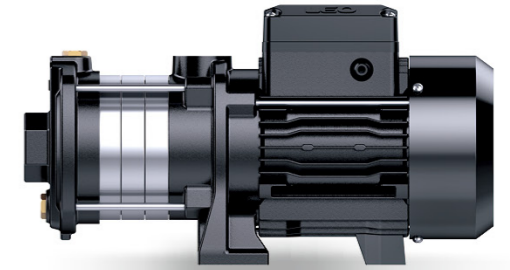
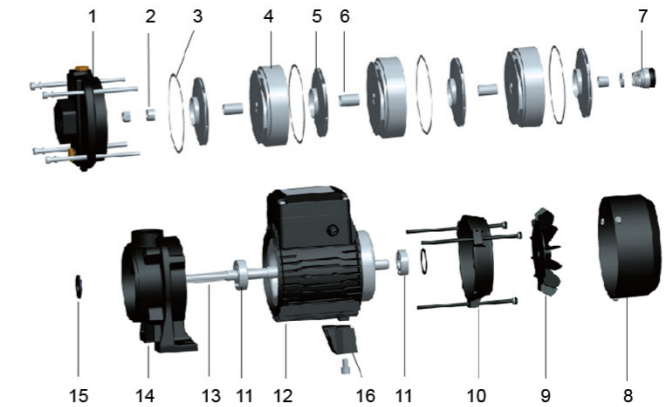

Hydraulic Performance Curves

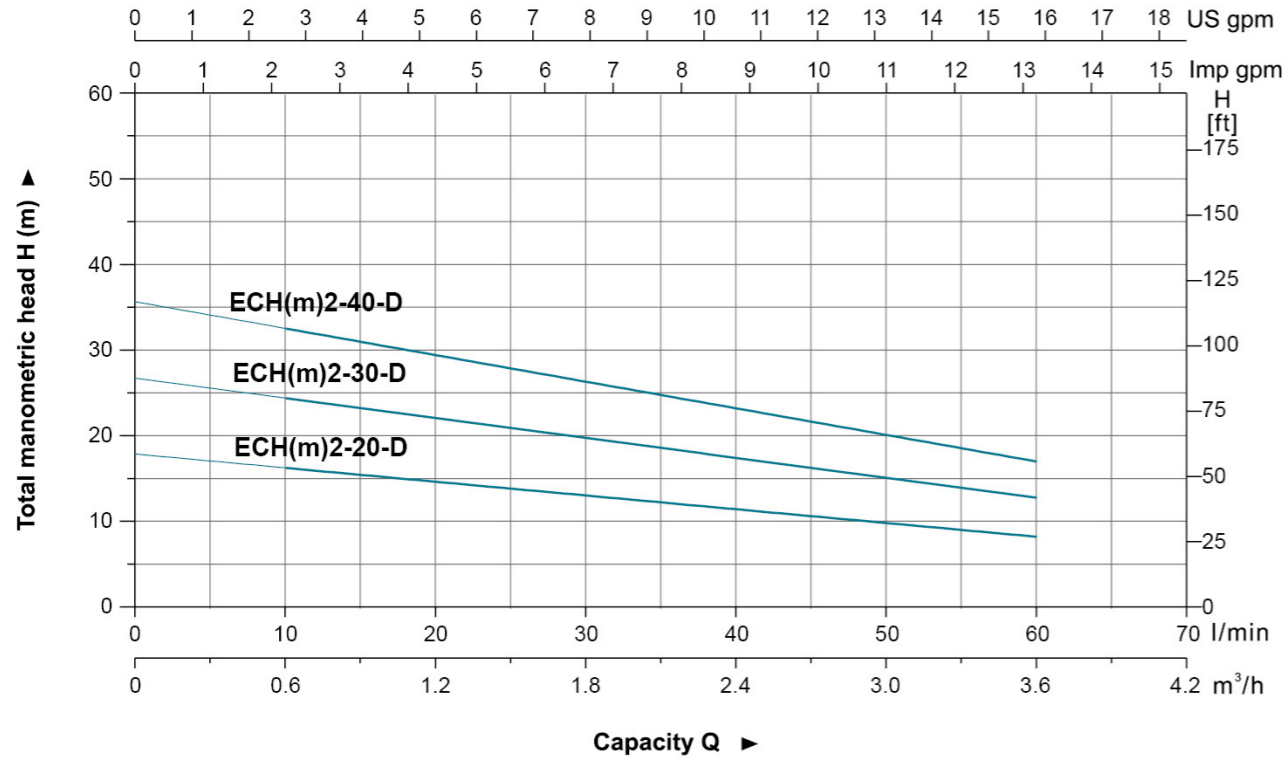

Technical Data

Model	Power		Q(m³/h) Q(l/min)	0.6	1.2	1.8	2.4	3.0	3.6
	kW	HP		H (m)					
ECH(m)2-20-D	0.37	0.5	H (m)	16	15	13	12	10	8
ECH(m)2-30-D	0.37	0.5		24	22	20	18	16	12
ECH(m)2-40-D	0.55	0.75		33	30	26	24	21	16

Dimension

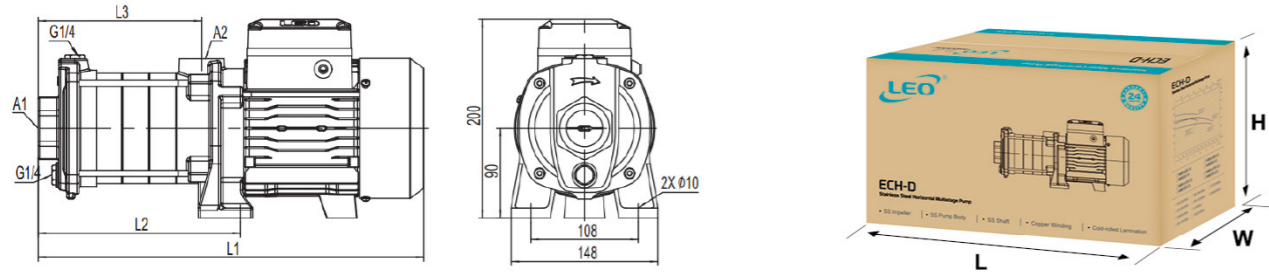

Model	L1	L2	L3	A1	A2	GW(kg)		L x W x H (mm)	Quantity (PCS/20'TEU)
						1~	3~		
ECH(m)2-20-D	324	140	101	G1	G1	10.3	10.7	375x185x237	1674
ECH(m)2-30-D	342	158	119	G1	G1	10.7	11	375x185x237	1674
ECH(m)2-40-D	360	176	137	G1	G1	12.4	12.6	420x185x237	1508

Hydraulic Performance Curves

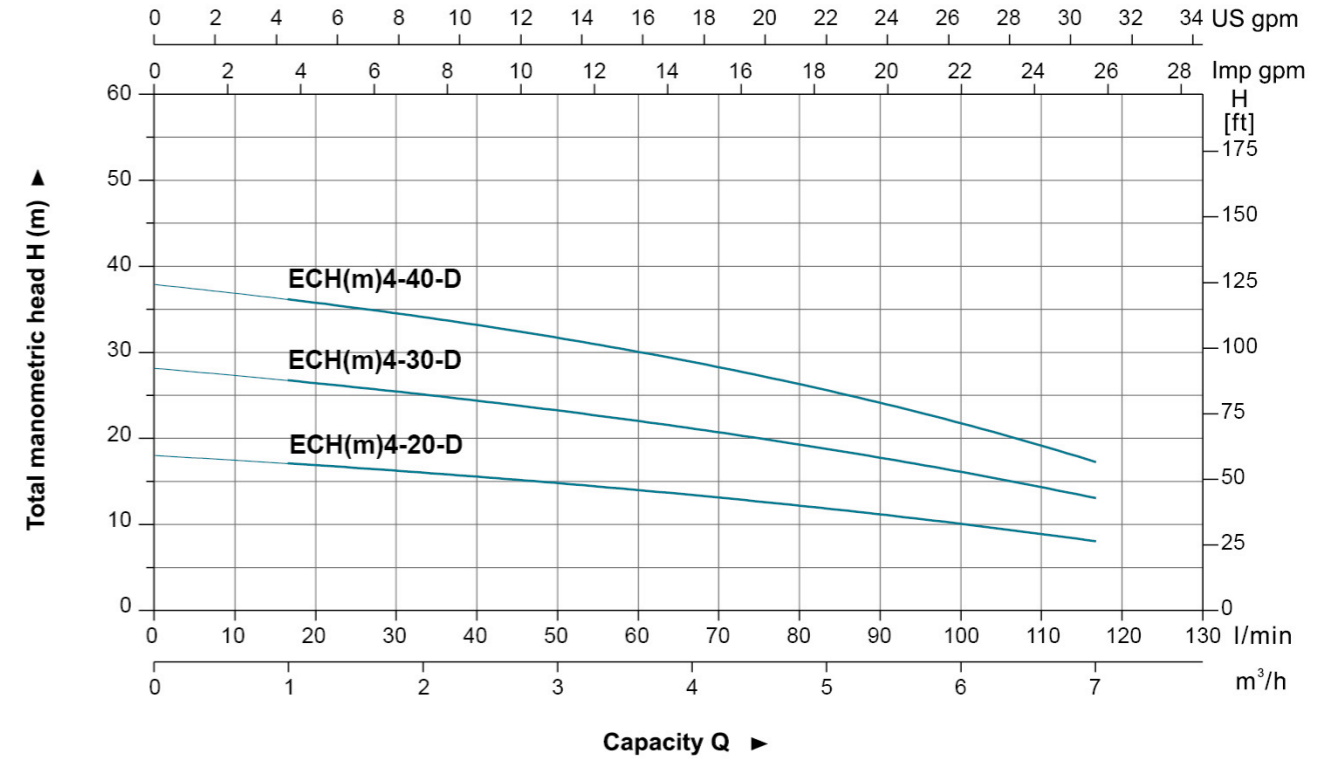

Technical Data

Model	Power		Q(m³/h) Q(l/min)	1	2	3	4	5	6	7
	kW	HP		H (m)						
ECH(m)4-20-D	0.55	0.75	H (m)	17	16	15	13	12	10	8
ECH(m)4-30-D	0.55	0.75		27	25	23	21	19	16	13
ECH(m)4-40-D	0.75	1.0		36	34	32	28	26	22	17

Dimension

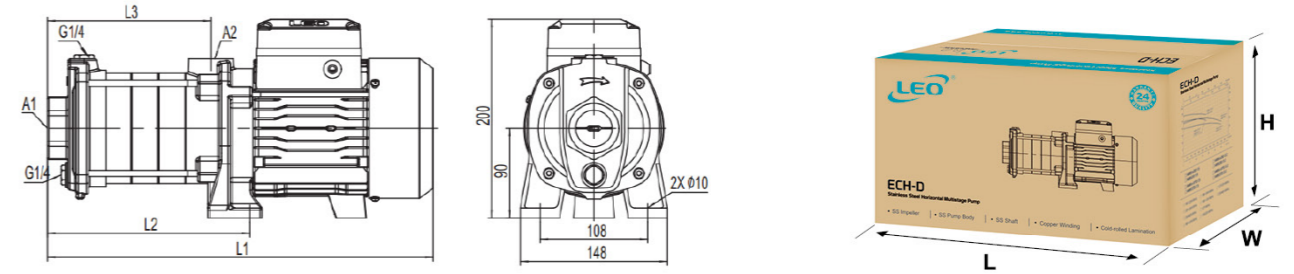

Model	L1	L2	L3	A1	A2	GW(kg)		L x W x H (mm)	Quantity (PCS/20'TEU)
						1~	3~		
ECH(m)4-20-D	334	150	111	G1 1/4	G1	11.7	12	375x185x237	1583
ECH(m)4-30-D	361	177	138	G1 1/4	G1	12.4	12.6	420x185x237	1508
ECH(m)4-40-D	388	204	165	G1 1/4	G1	13.8	14	420x185x237	1357

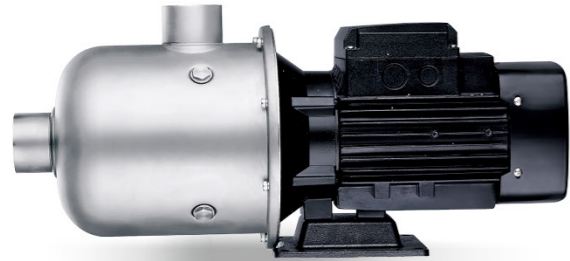

Application

- It is applicable to household water supply, equipment support, pipeline pressurization, garden watering, vegetable greenhouse watering, fish farming and poultry raising, industrial and mining, water supply and drainage of enterprises and high-rise buildings, central air conditioner and centralized heating circulation system, etc

Pump

- AISI 304 shaft
- Max. liquid temperature: +85°C
- Altitude: up to 1000 m
- Max. suction: 8 m
- Max. inlet pressure: limited by max. operating pressure
- Max. operation pressure: 10 bar
- Liquid PH Value: 4-10

Motor

- IE2 motor (IE3 motor available on request)
- Motor with copper winding
- Built-in thermal protector for single phase motor
- Insulation class: F
- Protection class: P55
- Max ambient temperature: +40°C

Identification Codes

EDH (m) 2 - 30

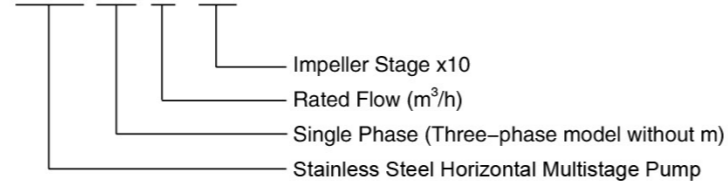

Application

- It is applicable to household water supply, equipment support, pipeline pressurization, garden watering, vegetable greenhouse watering, fish farming and poultry raising, supply and drainage of enterprises and high-rise buildings, central air conditioner and centralized heating circulation system, etc.

Pump

- AISI304 shaft
- Max. liquid temperature: +60°C
- Altitude: up to 1000 m
- Max. suction: 8 m
- Max. inlet pressure: limited by max. operating pressure
- Max. operation pressure: 10 bar
- Liquid PH value: 6.5 - 8.5

Motor

- IE2 motor
- Motor with copper winding
- Built-in thermal protector for single phase motor
- Insulation class: F
- Protection class: IPX4
- Max. ambient temperature: +40°C

Identification Codes

EDH (m) 2 - 20 - F

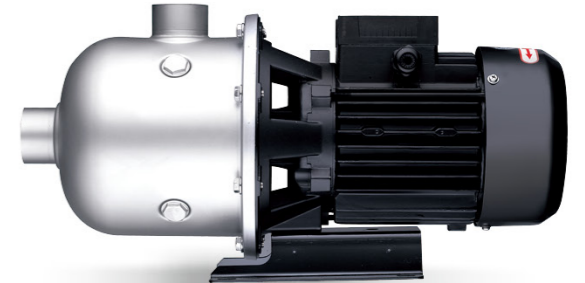
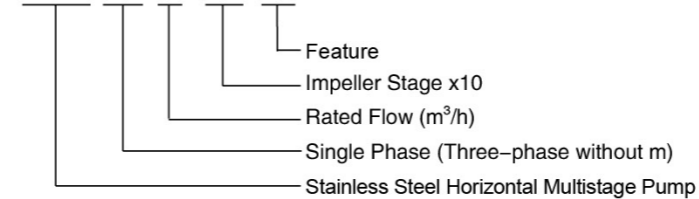

Materials Table

No.	Part	Material
1	Pump body	AISI 304
2	Support	ZL 102
3	Bottom plate	Cast iron
4	Stator	
5	Rotor	
6	Bearing	
7	Rear cover	ZL 102
8	Fan	PP
9	Fan cover	08F
10	Bracket cover	AISI 304
11	Mechanical seal	Sic/Carbon
12	Positioning sleeve	AISI 304
13	Diffuser 3	AISI 304
14	Diffuser 2	AISI 304
15	Sleeve	AISI 304
16	Impeller	AISI 304
17	Diffuser 1	AISI 304
18	Pressure plate	AISI 304
19	Spacer bush	AISI 304

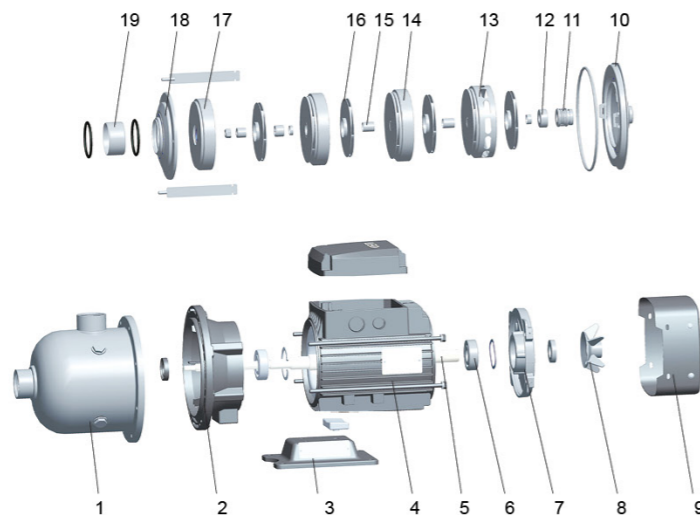

Materials Table

No.	Part	Material
1	Support	ZL 102
2	Base	W235
3	Stator	
4	Bearing	
5	Rotor	
6	Rear	ZL 102
7	Fan	PP
8	Fan cover	08F
9	Pump body	AISI 304
10	Spacer bush	AISI 304
11	Pressure plate	AISI 304
12	Diffuser1	AISI 304
13	Tension plate	AISI 304
14	Impeller	AISI 304
15	Sleeve	AISI 304
16	Diffuser2	AISI 304
17	Diffuser3	AISI 304
18	Mechanical seal	Sic/Carbon
19	Bracket cover	AISI 304
20	Terminal cover	Plastic

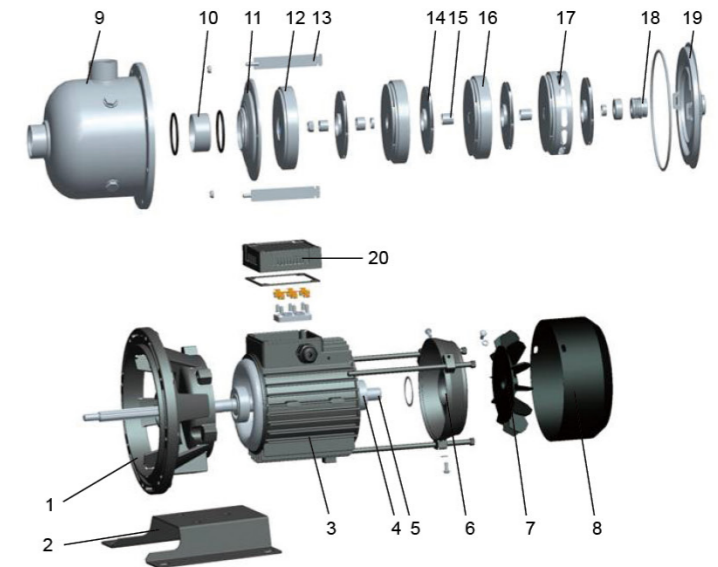

Scope of Performance - EDH

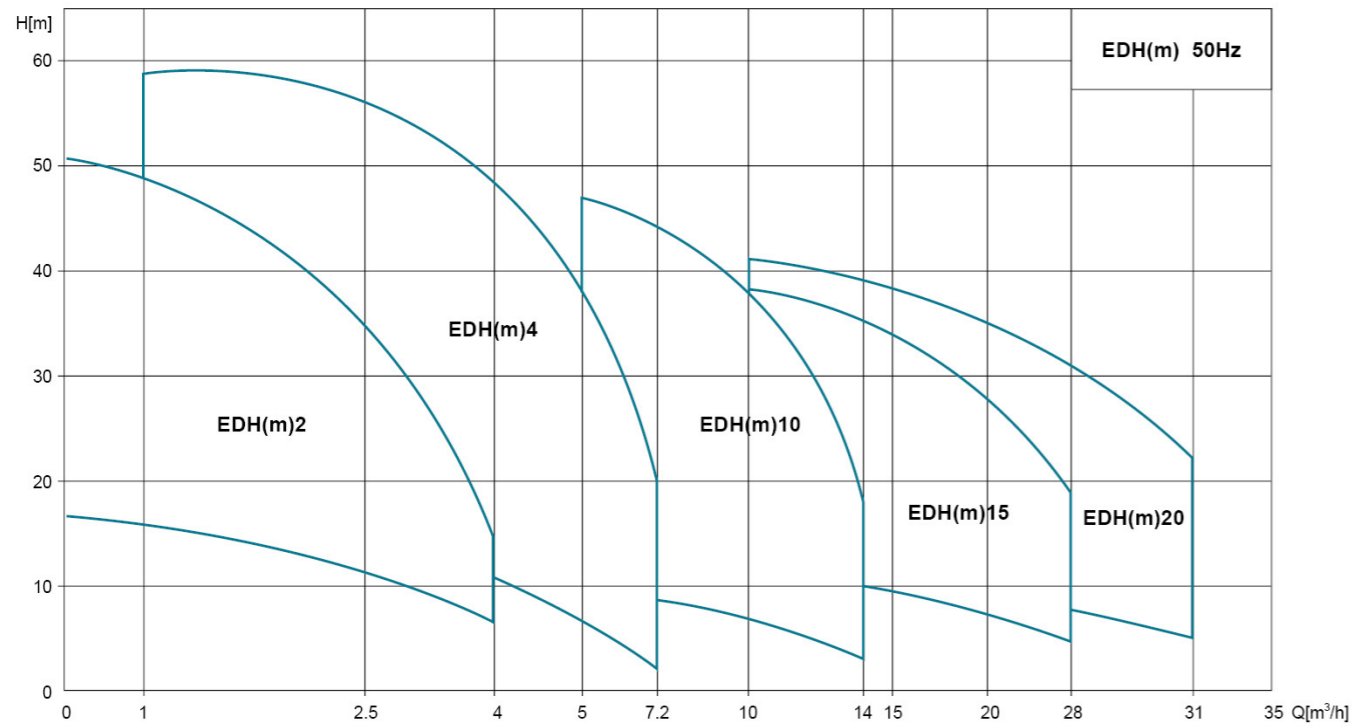

Hydraulic Performance Curves

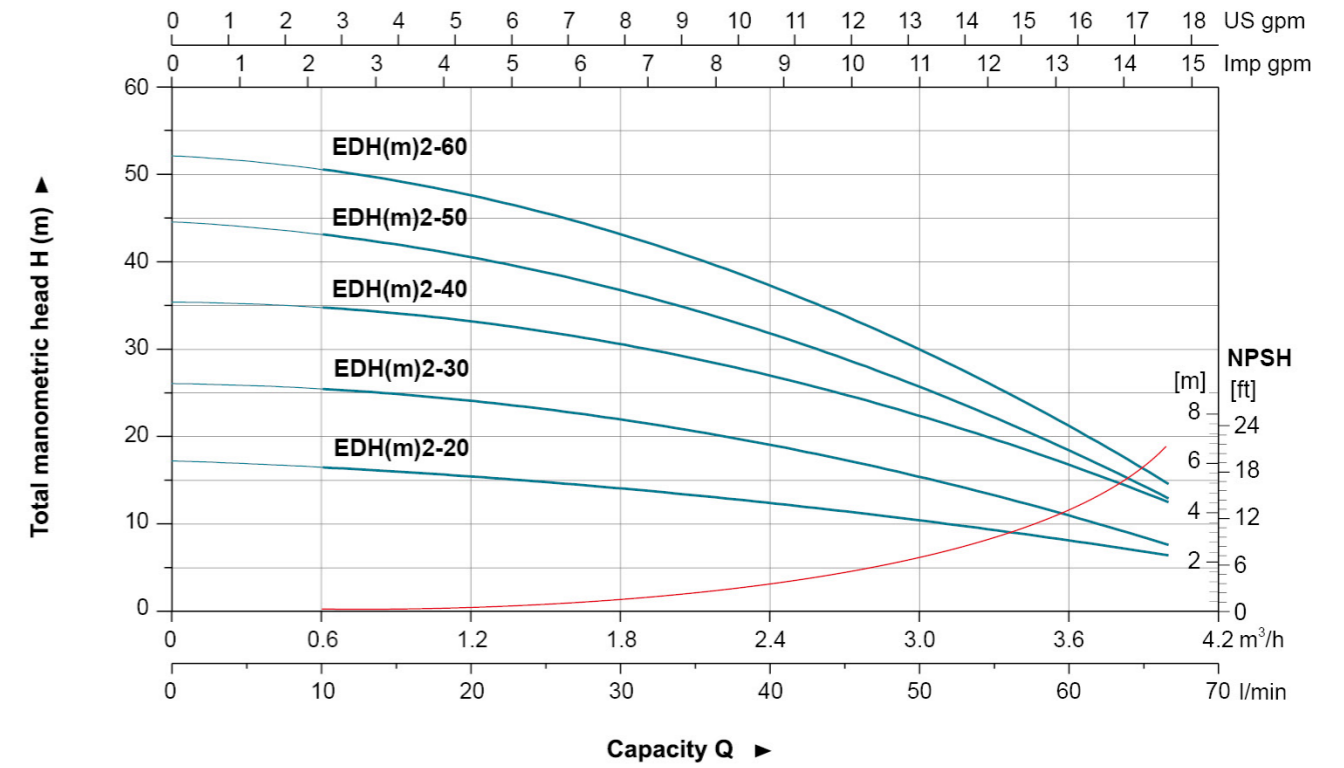

Scope of Performance - EDH-F

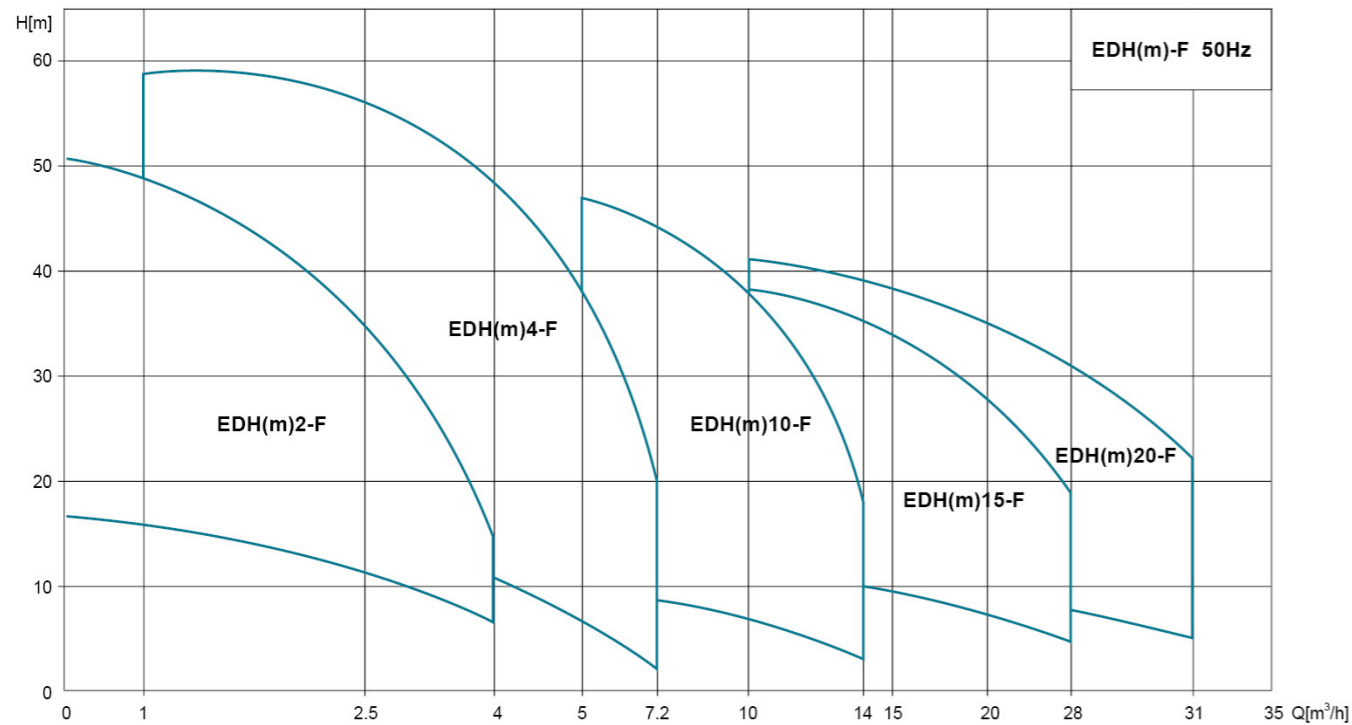

Technical Data

Model	Power		Q(m³/h) Q(l/min)	0.5	1	1.5	2	2.5	3	3.5	4
	kW	HP		H (m)	8.3	16.7	25	33.3	41.7	50	58.3
EDH(m)2-20	0.37	0.5	H (m)	16.7	16.2	15	14	11	10.6	8.8	6.5
EDH(m)2-30	0.37	0.5		25.8	24.3	23.8	21.3	17	16.1	12.5	7.2
EDH(m)2-40	0.55	0.75		34.8	34.1	33.2	30.7	23	22.9	18.4	12.6
EDH(m)2-50	0.55	0.75		43.5	42.1	39.5	35.9	29	25.7	19.6	13.5
EDH(m)2-60	0.75	1.0		50.8	49.2	45.6	41.5	35	30.4	23.4	14.3

Dimension

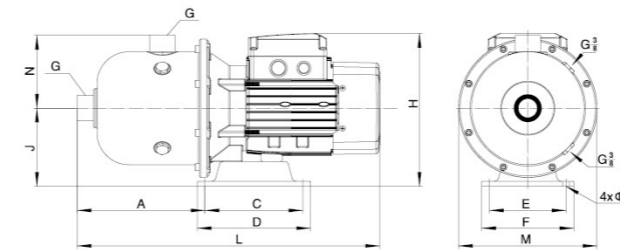

Model	L	A	C	D	E	F	G	H	J	M	N	GW (Kgs)	L x W x H (mm)	Quantity (PCS/20'TEU)
EDH(m)2-20	427	180	138	160	108	130	G1	216	110	Φ195	103	10.7	465x225x270	1044
EDH(m)2-30	427	180	138	160	108	130	G1	216	110	Φ195	103	11.1	465x225x270	1044
EDH(m)2-40	427	180	138	160	108	130	G1	216	110	Φ195	103	12.4	465x225x270	1044
EDH(m)2-50	427	180	138	160	108	130	G1	216	110	Φ195	103	12.8	465x225x270	1044
EDH(m)2-60	427	180	138	160	108	130	G1	216	110	Φ195	103	13.8	465x225x270	1044

Hydraulic Performance Curves

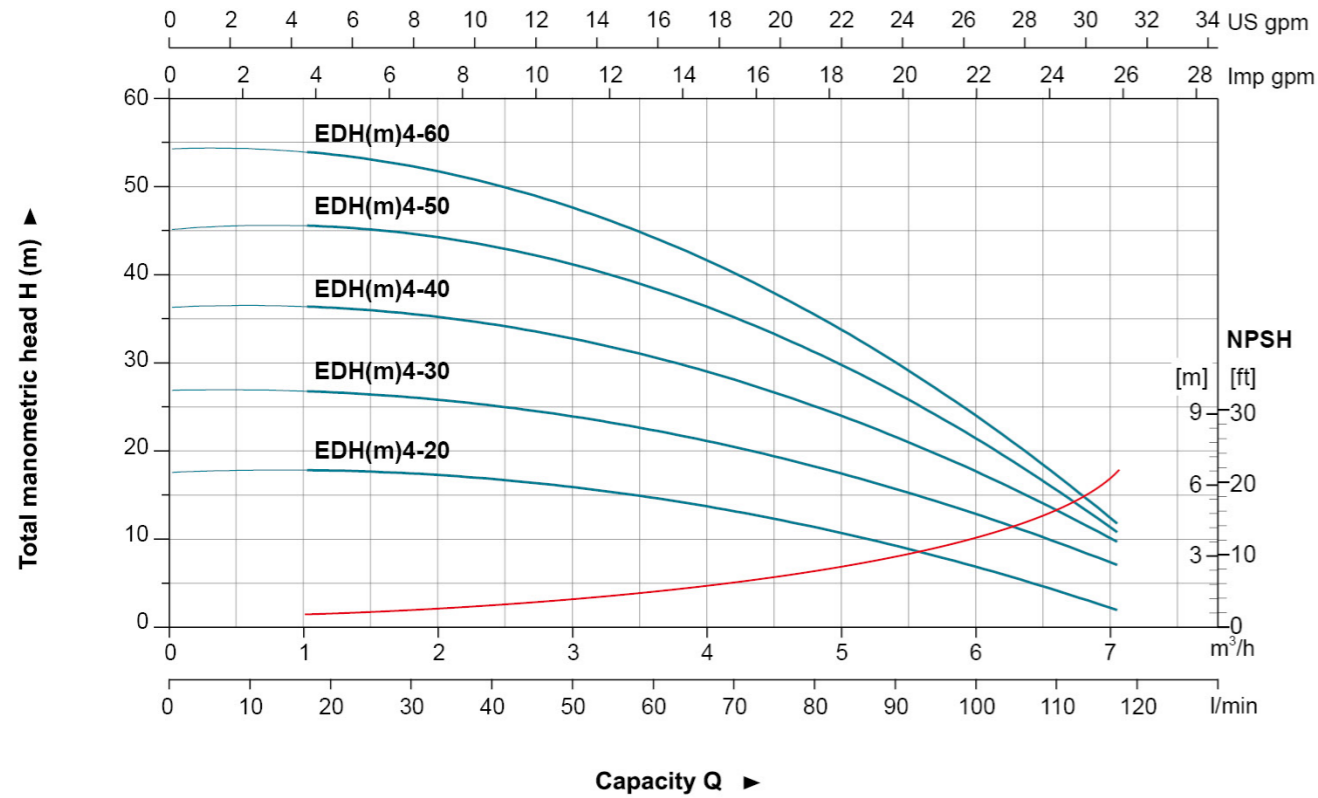

Hydraulic Performance Curves

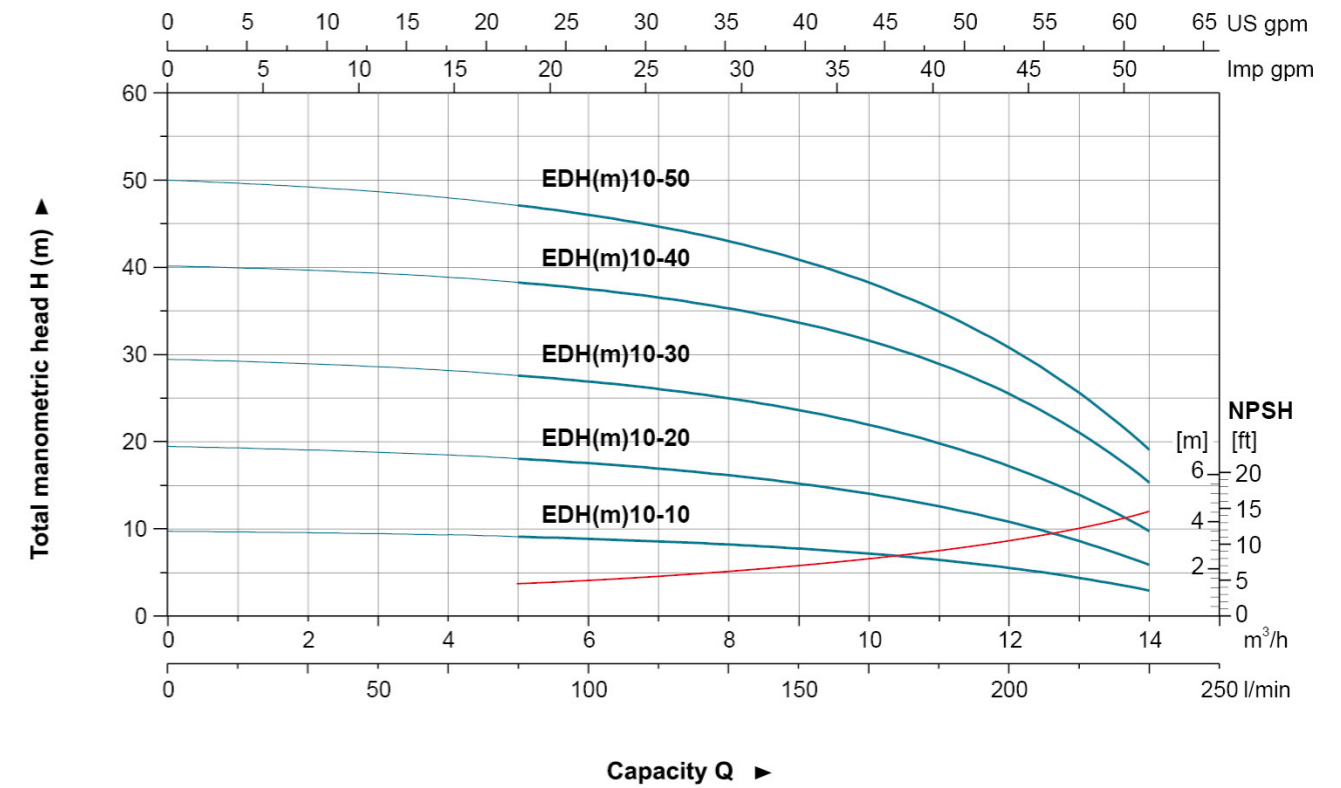

Technical Data

Model	Power		Q(m³/h) Q(l/min)	1	2	3	4	4.5	5	6	7
	kW	HP		17	33	50	67	75	83	100	117
EDH(m)4-20	0.55	0.75	H (m)	17.8	17.2	16.1	14.3	12	11.3	6.3	2.3
EDH(m)4-30	0.55	0.75		26.7	26.4	24.6	22.1	18	16.8	13.5	7.3
EDH(m)4-40	0.75	1.0		36.1	35.2	32.9	29.9	25	24.7	18.6	9.2
EDH(m)4-50	1.1	1.5		45.7	43.6	40.5	37	32	31.8	21.8	10
EDH(m)4-60	1.1	1.5		53.6	52	47	42.5	37	35	23	12

Technical Data

Model	Power		Q(m³/h) Q(l/min)	6	7	8	9	10	11	12	13	14
	kW	HP		100	117	133	150	167	183	200	217	233
EDH(m)10-10	0.75	1.0	H (m)	9.1	8.7	8.3	7.8	7.1	6.4	5.4	4.4	3.1
EDH(m)10-20	0.75	1.0		17.9	17.1	16.3	15.3	13.9	12.4	10.7	8.4	6.2
EDH(m)10-30	1.1	1.5		27.5	26.5	25.2	23.6	21.7	19.3	17	14	10
EDH(m)10-40	1.5	2.0		38.7	37.2	35.9	33.9	31.6	28.7	24.9	19.7	15.9
EDH(m)10-50	2.2	3.0		47.2	45.4	43.6	41	38.2	34.2	30	24.5	18

Dimension

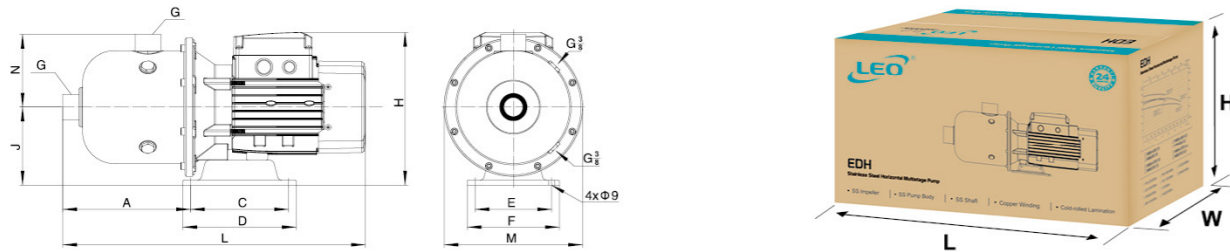

Model	L	A	C	D	E	F	G	H	J	M	N	GW (Kgs)	L x W x H (mm)	Quantity (PCS/20*TEU)
EDH(m)4-20	427	180	138	160	108	130	G1¼	216	110	Φ195	103	11.5	465x225x270	1044
EDH(m)4-30	427	180	138	160	108	130	G1¼	216	110	Φ195	103	12.9	465x225x270	1044
EDH(m)4-40	427	180	138	160	108	130	G1¼	216	110	Φ195	103	13.8	465x225x270	1044
EDH(m)4-50	480	180	138	160	108	130	G1¼	245	120	Φ195	103	18.2	515x225x297	870
EDH(m)4-60	480	180	138	160	108	130	G1¼	245	120	Φ195	103	18.6	515x225x297	870

Dimension

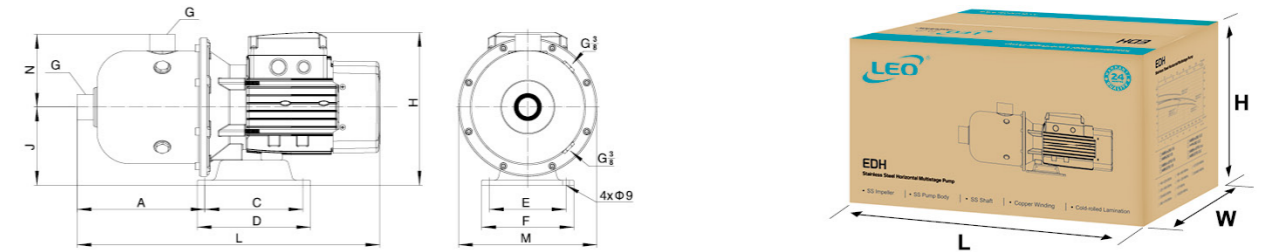

Model	L	A	C	D	E	F	G	H	J	M	N	GW (Kgs)	L x W x H (mm)	Quantity (PCS/20*TEU)
EDH(m)10-10	568	278	138	160	108	130	G2	245	120	Φ233	140	21.5	610x265x317	540
EDH(m)10-20	568	278	138	160	108	130	G2	245	120	Φ233	140	22	610x265x317	540
EDH(m)10-30	568	278	138	160	108	130	G2	245	120	Φ233	140	23	610x265x317	540
EDH(m)10-40	626	287	138	160	108	130	G2	248	120	Φ233	140	29	660x265x317	480
EDH(m)10-50	626	287	138	160	108	130	G2	248	120	Φ233	140	30.7	660x265x317	480

Hydraulic Performance Curves

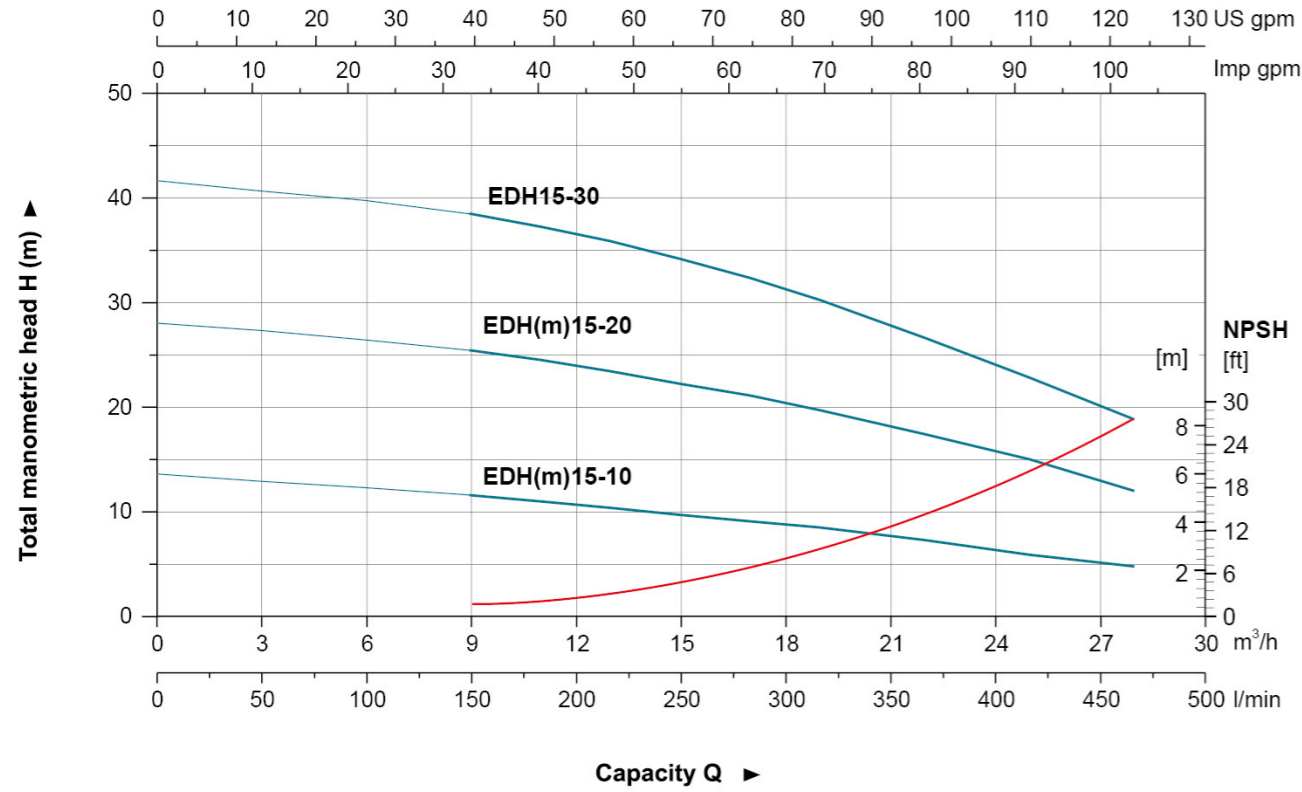

Hydraulic Performance Curves

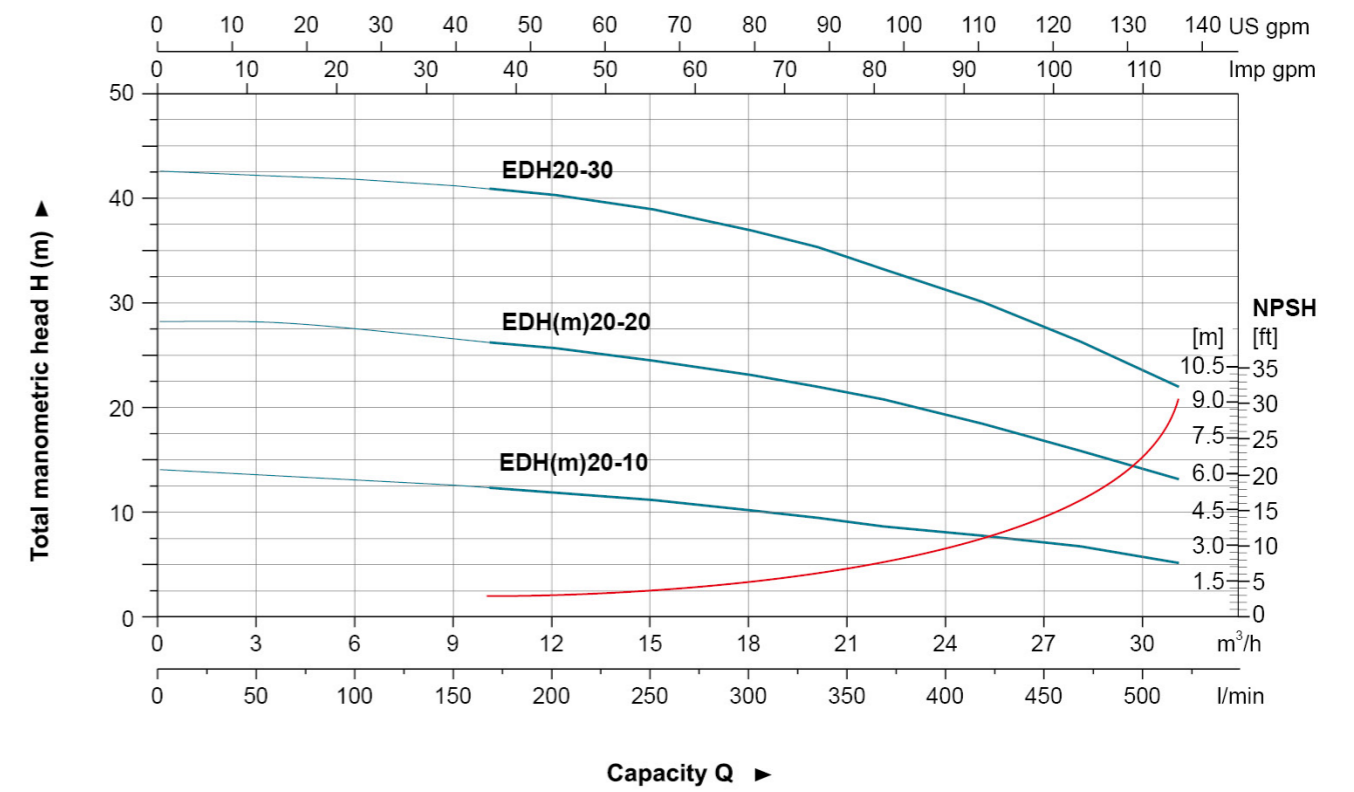

Technical Data

Model	Power		Q(m³/h) Q(l/min)	9	11	13	15	17	19	22	25	28
	kW	HP		H (m)								
EDH(m)15-10	1.1	1.5	H (m)	11.6	11	10.4	9.7	9.1	8.5	7.7	5.9	4.8
EDH(m)15-20	2.2	3.0		25.4	24.5	23.4	22.2	21.1	19.7	17.4	15	12
EDH15-30	3.0	4.0		38.4	37.2	35.8	34.1	32.3	30.2	26.6	22.8	18.8

Technical Data

Model	Power		Q(m³/h) Q(l/min)	9	12	15	18	20	22	25	28	31
	kW	HP		H (m)								
EDH(m)20-10	1.1	1.5	H (m)	12.6	11.9	11.2	10.2	9.8	8.7	8	6.8	5.2
EDH(m)20-20	2.2	3.0		26.5	25.7	24.5	23.1	22	20.8	18.5	15.9	13.2
EDH20-30	4.0	5.5		41.2	40.3	38.9	36.9	35.3	33.2	30.1	26.3	22

Dimension

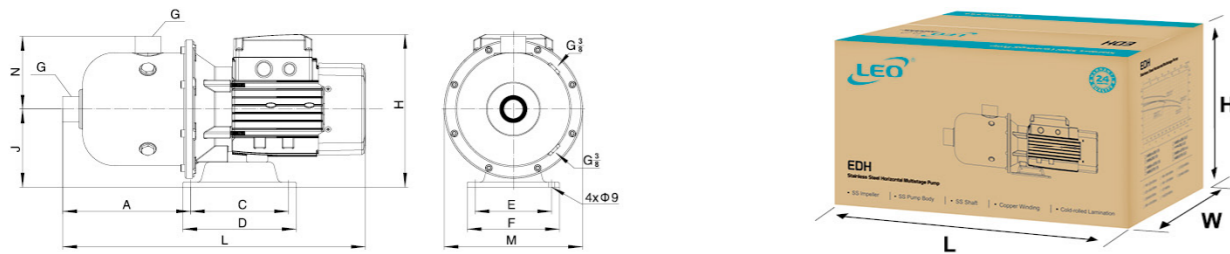

Model	L	A	C	D	E	F	G	H	J	M	N	GW (Kgs)	L x W x H (mm)	Quantity (PCS/20'TEU)
EDH(m)15-10	568	278	138	160	108	130	G2	245	120	Φ233	140	20.5	610x265x317	540
EDH(m)15-20	626	287	138	160	108	130	G2	248	120	Φ233	140	28.8	660x265x317	480
EDH15-30	626	287	138	160	108	130	G2	248	120	Φ233	140	33	660x265x317	480

Dimension

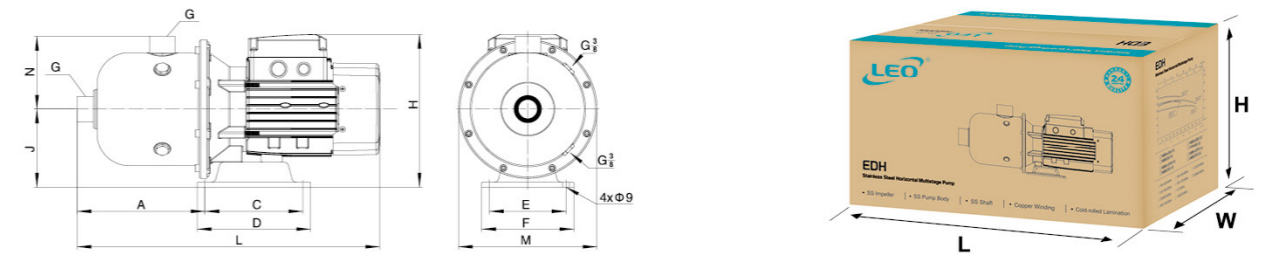

Model	L	A	C	D	E	F	G	H	J	M	N	GW (Kgs)	L x W x H (mm)	Quantity (PCS/20'TEU)
EDH(m)20-10	568	278	138	160	108	130	G2	245	120	Φ233	140	20.5	610x265x317	540
EDH(m)20-20	626	287	138	160	108	130	G2	248	120	Φ233	140	28.8	660x265x317	480
EDH20-30	642	278	190	220	170	200	G2	240	120	Φ233	140	37.5	675x265x317	480

Hydraulic Performance Curves

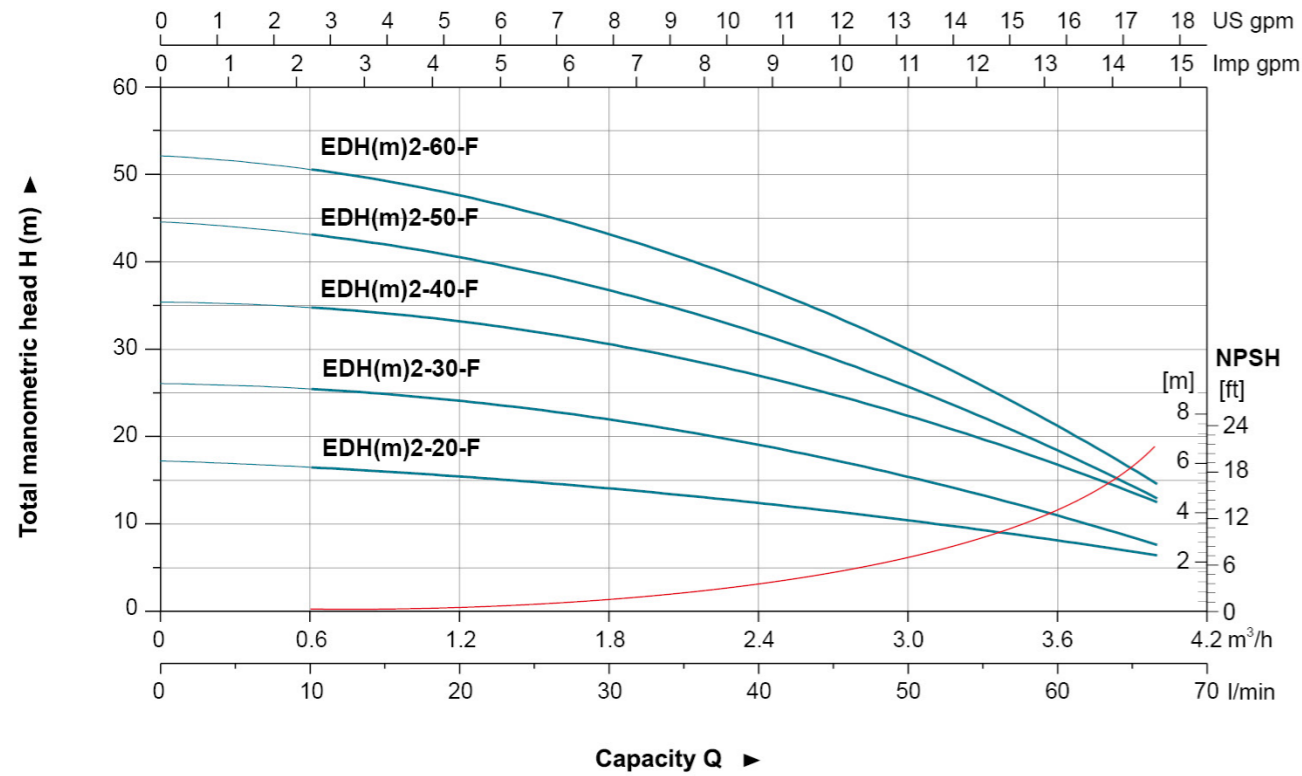

Hydraulic Performance Curves

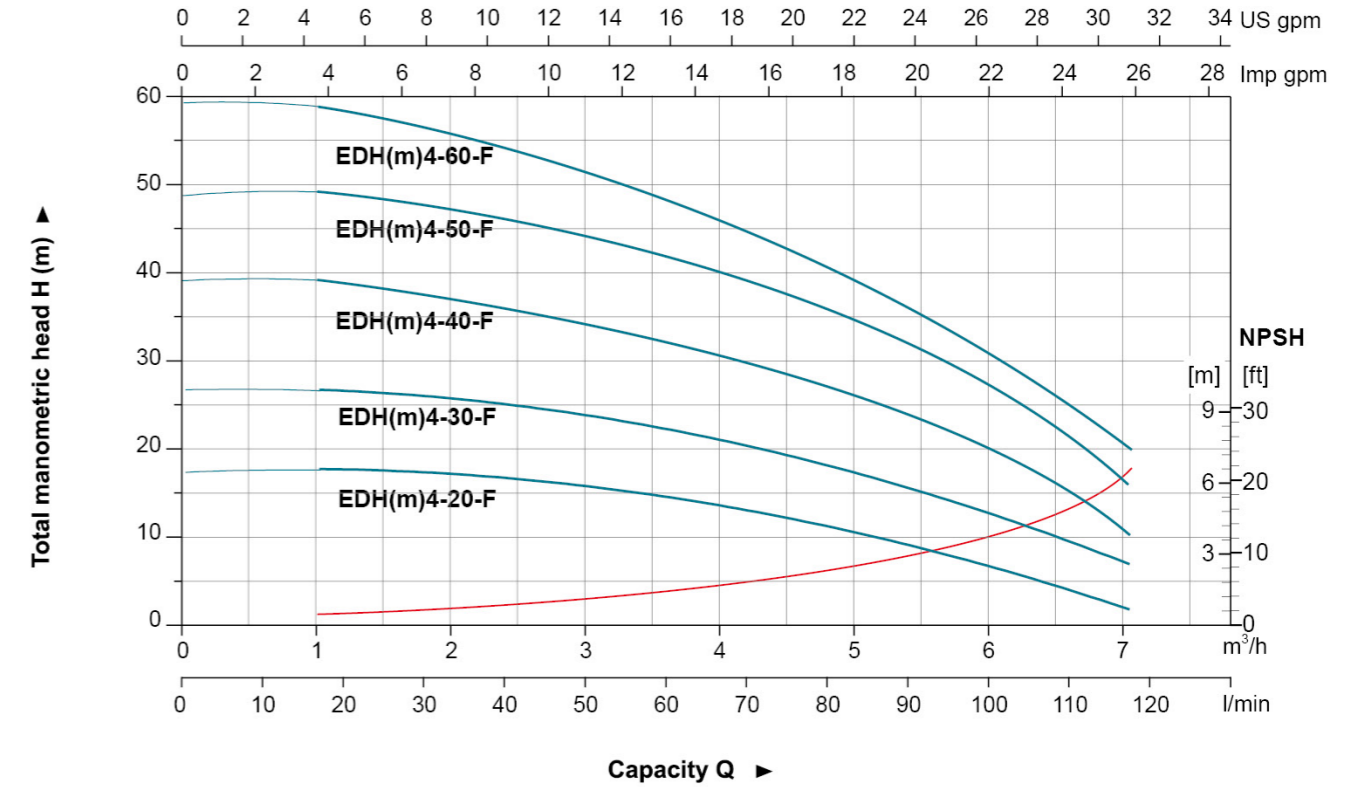

Technical Data

Model	Power		Q(m³/h) Q(l/min)	0.5	1	1.5	2	2.5	3	3.5	4
	kW	HP		H (m)	8.3	16.7	25	33.3	41.7	50	58.3
EDH(m)2-20-F	0.37	0.5	H (m)	16.7	16.2	15	14	12	10.6	8.8	6.5
EDH(m)2-30-F	0.37	0.5		25.7	24.3	23.8	21.3	19	16.1	12.5	7.2
EDH(m)2-40-F	0.55	0.75		34.9	34.1	33.2	30.7	23	22.9	18.4	12.6
EDH(m)2-50-F	0.55	0.75		43.5	42.1	39.5	35.9	29	25.7	19.6	13.5
EDH(m)2-60-F	0.75	1.0		50.8	49.2	45.6	41.5	35	30.4	23.4	14.3

Technical Data

Model	Power		Q(m³/h) Q(l/min)	1	2	3	4	4.5	5	6	7
	kW	HP		H (m)	17	33	50	67	75	83	100
EDH(m)4-20-F	0.55	0.75	H (m)	17.8	17.2	16.1	14.3	12	11.3	6.3	2.3
EDH(m)4-30-F	0.55	0.75		26.7	26.4	24.6	22.1	18	16.8	13.5	7.3
EDH(m)4-40-F	0.75	1.0		39	37	34	31.5	29	27	20	11
EDH(m)4-50-F	1.1	1.5		49	47	44	41	37	35	27	17
EDH(m)4-60-F	1.1	1.5		59	55	52	47	43	39	29	20

Dimension

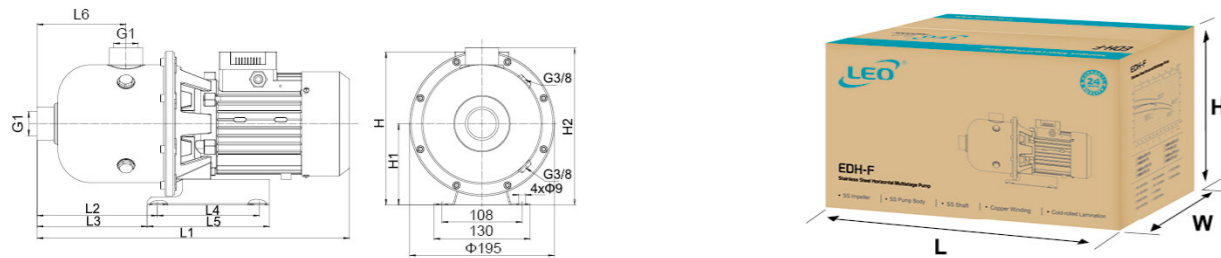

Model	L1	L2	L3	L4	L5	L6	H		H1	H2	GW (Kgs)	L x W x H (mm)	Quantity (PCS/20*TEU)
							1~	3~					
EDH(m)2-20-F	426	162	148.5	138	165	120	197.5	187	110	213	10.7	460x225x275	1044
EDH(m)2-30-F	426	162	148.5	138	165	120	197.5	187	110	213	11.1	460x225x275	1044
EDH(m)2-40-F	426	162	148.5	138	165	120	197.5	187	110	213	12.4	460x225x275	1044
EDH(m)2-50-F	426	162	148.5	138	165	120	197.5	187	110	213	12.8	460x225x275	1044
EDH(m)2-60-F	426	162	148.5	138	165	120	197.5	187	110	213	13.8	460x225x275	1044

Dimension

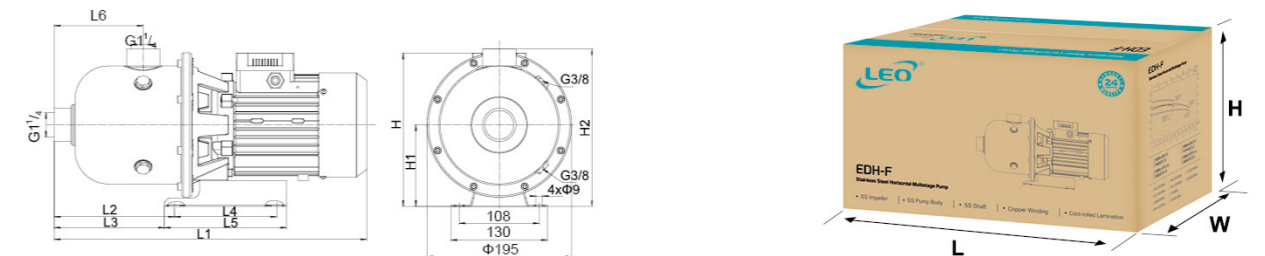

Model	L1	L2	L3	L4	L5	L6	H		H1	H2	GW (Kgs)	L x W x H (mm)	Quantity (PCS/20*TEU)
							1~	3~					
EDH(m)4-20-F	429	165	151.5	138	165	123	197.5	187	110	215.5	11.5	460x225x275	1044
EDH(m)4-30-F	429	165	151.5	138	165	123	197.5	187	110	215.5	12.9	460x225x275	1044
EDH(m)4-40-F	429	165	151.5	138	165	123	197.5	187	110	215.5	13.8	460x225x275	1044
EDH(m)4-50-F	429	165	151.5	138	165	123	197.5	187	110	215.5	18.2	460x225x275	1044
EDH(m)4-60-F	429	165	151.5	138	165	123	197.5	187	110	215.5	18.6	460x225x275	1044

Hydraulic Performance Curves

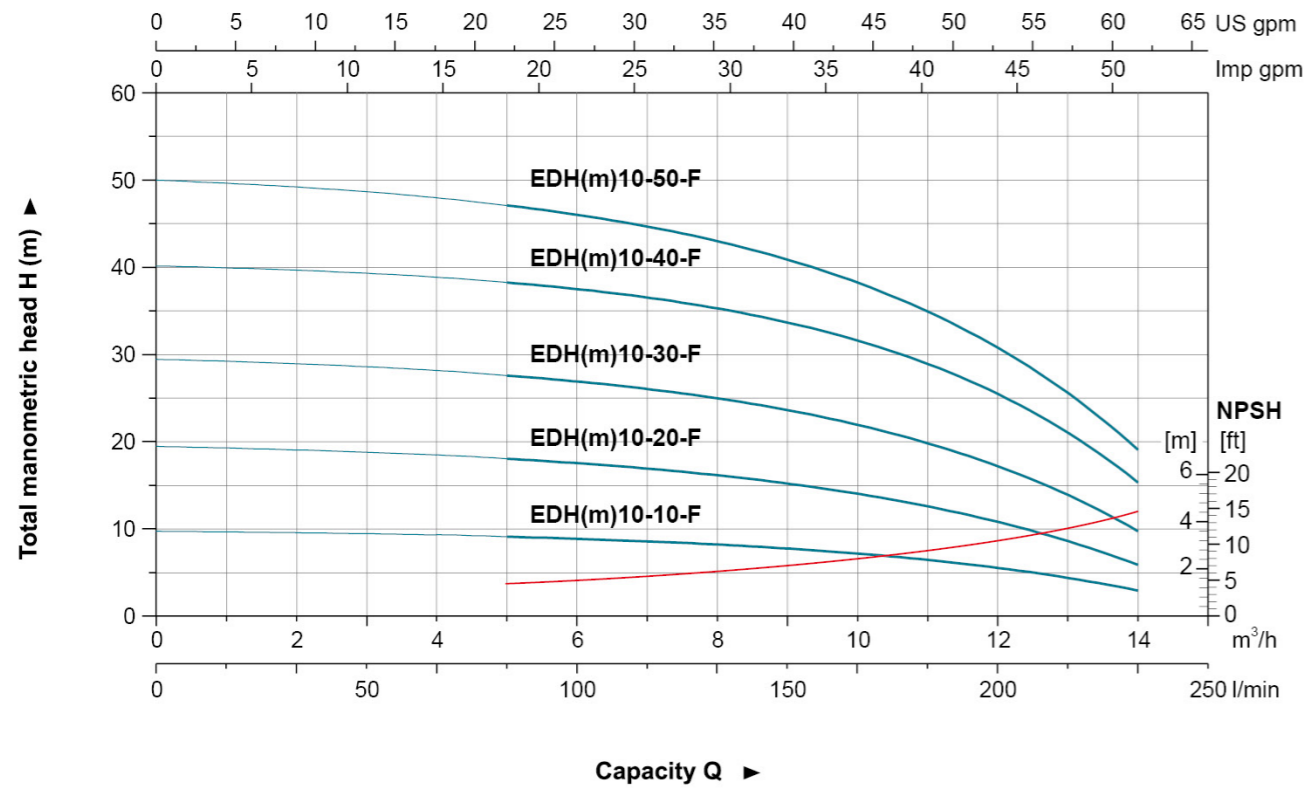

Hydraulic Performance Curves

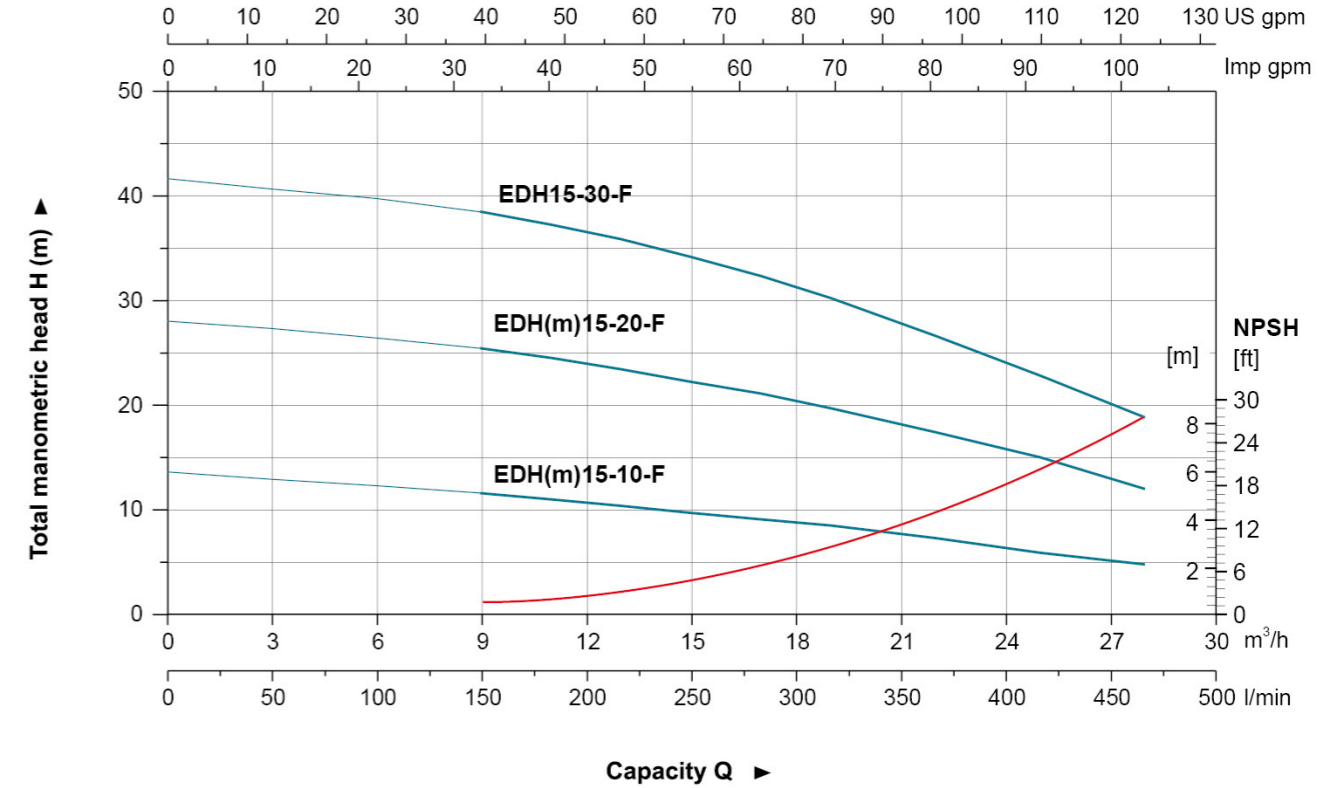

Technical Data

Model	Power		Q(m³/h) Q(l/min)	5	7	8	9	10	11	12	13	14
	kW	HP		H (m)	83	117	133	150	167	183	200	217
EDH(m)10-10-F	0.75	1.0	H (m)	9.1	8.7	8.3	7.8	7	6.4	5.4	4.4	3.1
EDH(m)10-20-F	0.75	1.0		17.9	17.1	16.3	15.3	13.5	12.4	10.7	8.4	6.2
EDH(m)10-30-F	1.1	1.5		27.5	26.5	25.2	23.6	21.5	19.3	17	14	10
EDH(m)10-40-F	1.5	2.0		38.7	37.2	35.9	33.9	31.5	28.7	24.9	19.7	15.9
EDH(m)10-50-F	2.2	3.0		47.2	45.4	43.6	41	38	34.2	30	24.5	18

Technical Data

Model	Power		Q(m³/h) Q(l/min)	9	11	13	15	17	19	22	25	28
	kW	HP		H (m)	150	183	217	250	283	317	367	417
EDH(m)15-10-F	1.1	1.5	H (m)	11.6	11	10.4	9.5	9.1	8.5	7.7	5.9	4.8
EDH(m)15-20-F	2.2	3.0		25.4	24.5	23.4	22	21.1	19.7	17.4	15	12
EDH(m)15-30-F	3.0	4.0		38.4	37.2	35.8	34	32.3	30.2	26.6	22.8	18.8
EDH15-30-F												

Dimension

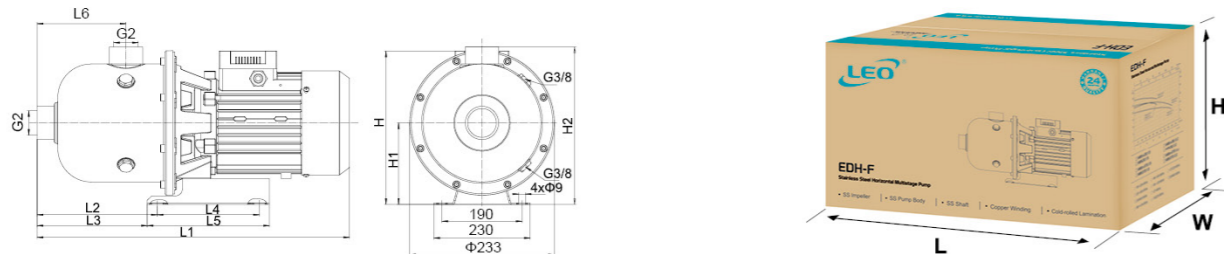

Model	L1	L2	L3	L4	L5	L6	H		H1	H2	GW (Kgs)	L x W x H (mm)	Quantity (PCS/20'TEU)
							1~	3~					
EDH(m)10-10-F	557	288	273	140	170	188	232.5	226	120	260	21.5	610x265x317	540
EDH(m)10-20-F	557	288	273	140	170	188	232.5	226	120	260	22.0	610x265x317	540
EDH(m)10-30-F	557	288	273	140	170	188	232.5	226	120	260	23.0	610x265x317	540
EDH(m)10-40-F	600	288	273	140	170	188	236	230	120	260	29.0	660x265x317	480
EDH(m)10-50-F	600	288	273	140	170	188	242	230	120	260	30.7	660x265x317	480

Dimension

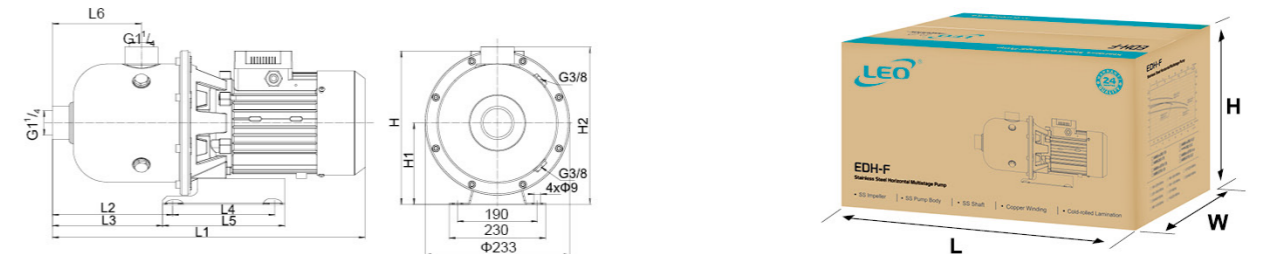

Model	L1	L2	L3	L4	L5	L6	H		H1	H2	GW (Kgs)	L x W x H (mm)	Quantity (PCS/20'TEU)
							1~	3~					
EDH(m)15-10-F	557	288	273	140	170	188	232.5	226	120	260	20.5	610x265x317	540
EDH(m)15-20-F	600	288	273	140	170	188	242	230	120	260	28.8	660x265x317	480
EDH15-30-F	620	288	273	140	170	188	250	250	120	260	33	660x265x317	480

Hydraulic Performance Curves

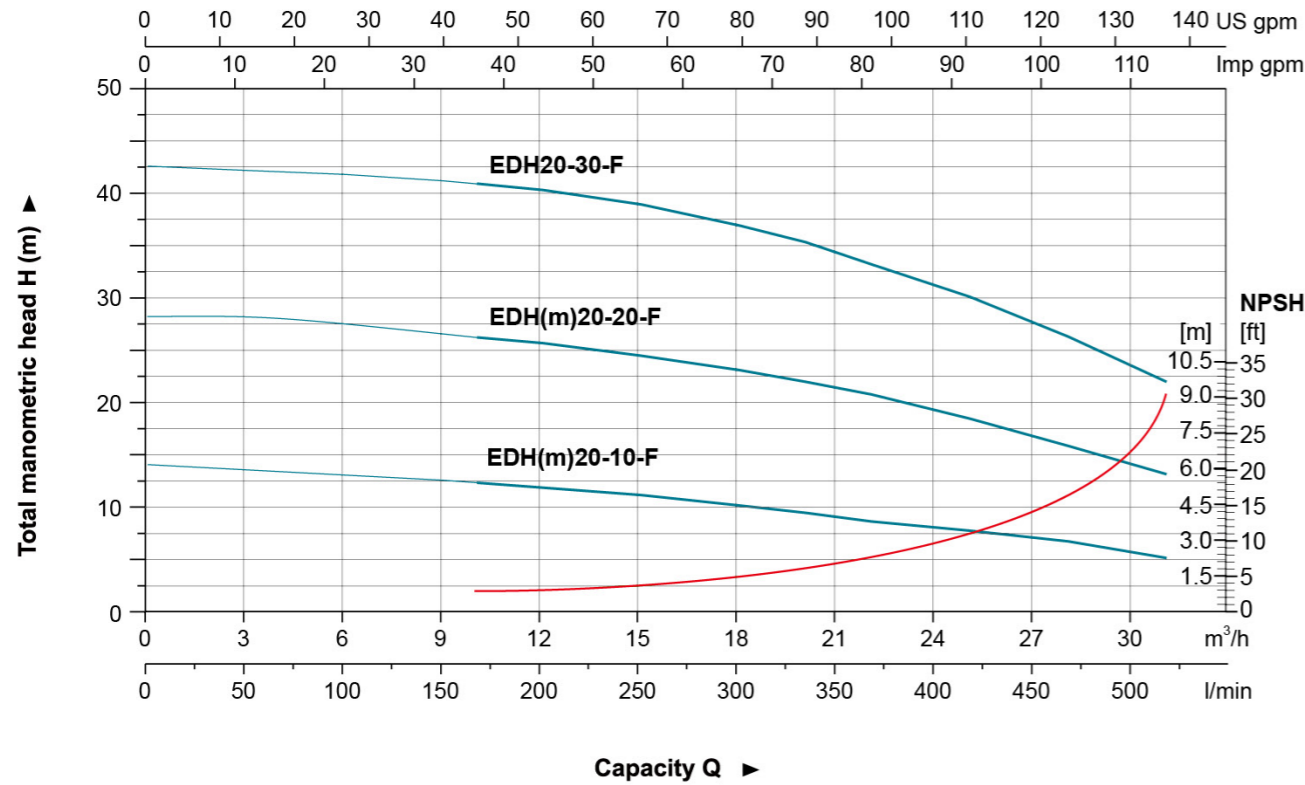

Technical Data

Model	Power		Q(m³/h) Q(l/min)	9	12	15	18	20	22	25	28	31
	kW	HP		H (m)								
EDH(m)20-10-F	1.1	1.5		12.4	11.9	11.2	10.2	9.5	8.7	8	6.8	5.2
EDH(m)20-20-F	2.2	3.0		26.5	25.7	24.5	23.1	22	20.8	18.5	15.9	13.2
EDH20-30-F	4.0	5.5		41.2	40.3	38.9	36.9	35	33.2	30.1	26.3	22

Dimension

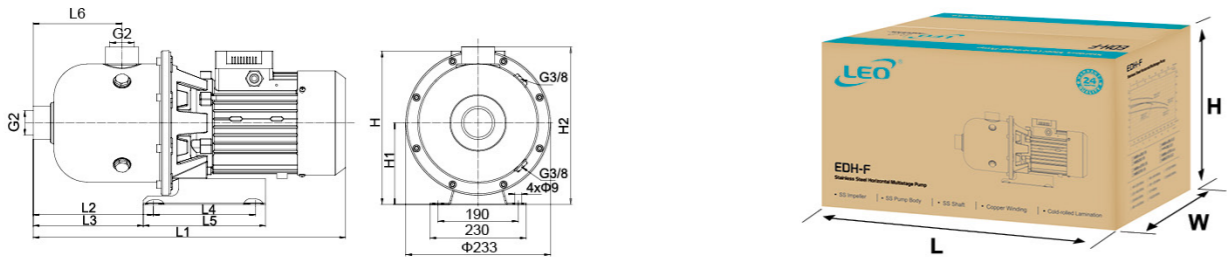

Model	L1	L2	L3	L4	L5	L6	H		H1	H2	GW (Kgs)	L x W x H (mm)	Quantity (PCS/20'TEU)
							1~	3~					
EDH(m)20-10-F	557	288	273	140	170	188	232.5	226	120	260	20.5	610x265x317	540
EDH(m)20-20-F	600	288	273	140	170	188	242	230	120	260	28.8	660x265x317	480
EDH20-30-F	620	288	273	140	170	188	250	250	120	260	37.5	675x265x317	480

Intelligent Pressure Booster System

Features

- Constant pressure by integrated variable speed controller
- Reliable AISI304 wetted parts for long service life
- Easy installation & operation
- Dry running protection
- Anti freezing
- Quiet operation
- Compact structure

Product Components

- Three phase ECH-(F) or EDH-(F) pump
- Integrated inverter (variable speed controller)
- 5-Way connector with on-return valve
- Pressure gauge & Pressure sensor
- 5L pressure tank

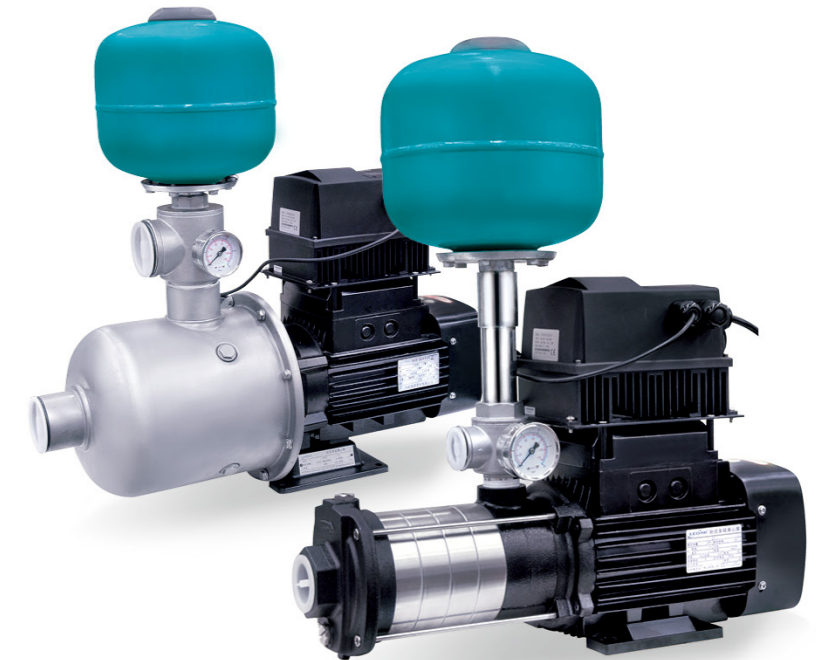

Pump With Automatic Electronic Pressure Switch

Features

- Horizontal multistage pump fitted with an electronic pressure switch that starts/stops the pump as required when water tap is turned on/off
- Reliable AISI304 wetted parts for long service life
- Dry running protection
- Easy installation & operation
- Compact structure

Product Components

- ECH-(F) or EDH-(F) series single phase pump
- PS-04 Series Electronic pressure switch(5)
- Quick-fit joint
- 1.6 metres power cable with plug





Application

- Can be used to transfer liquids with light corrosive, requirement for health and containing impurities, etc.
- Suitable for industrial & domestic sewage system, food & beverage processing, farming, pumping water from river and lake, etc.
- Can be used at full head without overloading motor.

Pump

- AISI 304 pump body
- AISI 304 shaft
- Liquid temperature: -15°C ~ +80°C
- Liquid PH value: 5 - 9
- Max. solid diameter: 19 mm

Motor

- Motor with copper winding
- Built-in thermal protector for single phase motor
- Insulation class: F
- Protection class: IPX4
- Max. temperature: +40°C

Identification Codes

ABK 200 D

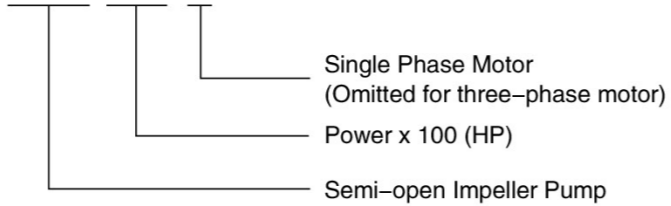

Technical Data

MODEL		POWER		Q (m³/h)														Impeller passage (mm)
Single Phase	Three Phase	kW	HP	1.2	2.4	3.6	4.8	6	12	18	24	33	42	48	57	66		
ABK50D	ABK50	0.37	0.5	20	40	60	80	100	200	300	400	550	700	800	950	1100	H (m)	9
ABK100D	ABK100	0.75	1	11.6	10.5	9.7	8.7	7.5	-	-	-	-	-	-	-	-		12
ABK120D	ABK120	0.9	1.2	-	-	-	-	8	7	5	-	-	-	-	-	-		12
ABK150D	ABK150	1.1	1.5	-	-	-	-	11	10	9	-	-	-	-	-	-		12
ABK200D	ABK200	1.5	2	-	-	-	-	9.5	8.8	7.8	6.7	5	-	-	-	-		16
ABK300D	ABK300	2.2	3	-	-	-	-	12.7	12	11.2	10	8.3	6.5	-	-	-		16
-	ABK400	3	4	-	-	-	-	15	14	13.5	12.7	11.2	9.8	8.9	7.5	-		16
-	ABK400	3	4	-	-	-	-	17.5	16.8	16	15.2	14	12.5	11.5	9.7	7.5		19

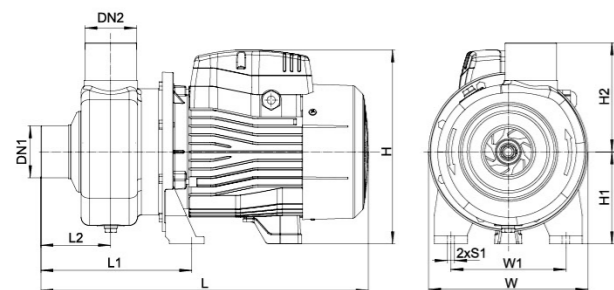

Dimension

Model	Ports		L (mm)	L ₁ (mm)	L ₂ (mm)	H (mm)	H ₁ (mm)	H ₂ (mm)	W (mm)	W ₁ (mm)	S ₁ (mm)
	DN1	DN2									
ABK50(D)	1 1/4"	1"	280	123	50	180	90	106	170	105	9
ABK100(D)	1 1/2"	1 1/2"	332	160	76	212	100	118	170	120	9
ABK120(D)	1 1/2"	1 1/2"	332	160	76	212	100	118	170	120	9
ABK150(D)	2"	2"	400	184	85	235	112	133	195	140	9
ABK200(D)	2"	2"	400	184	85	235	112	133	195	140	9
ABK300(D)	2 1/2"	2"	450	184	85	252	117	133	195	140	9
ABK400	2 1/2"	2"	450	184	85	252	117	133	195	140	9

Hydraulic Performance Curves

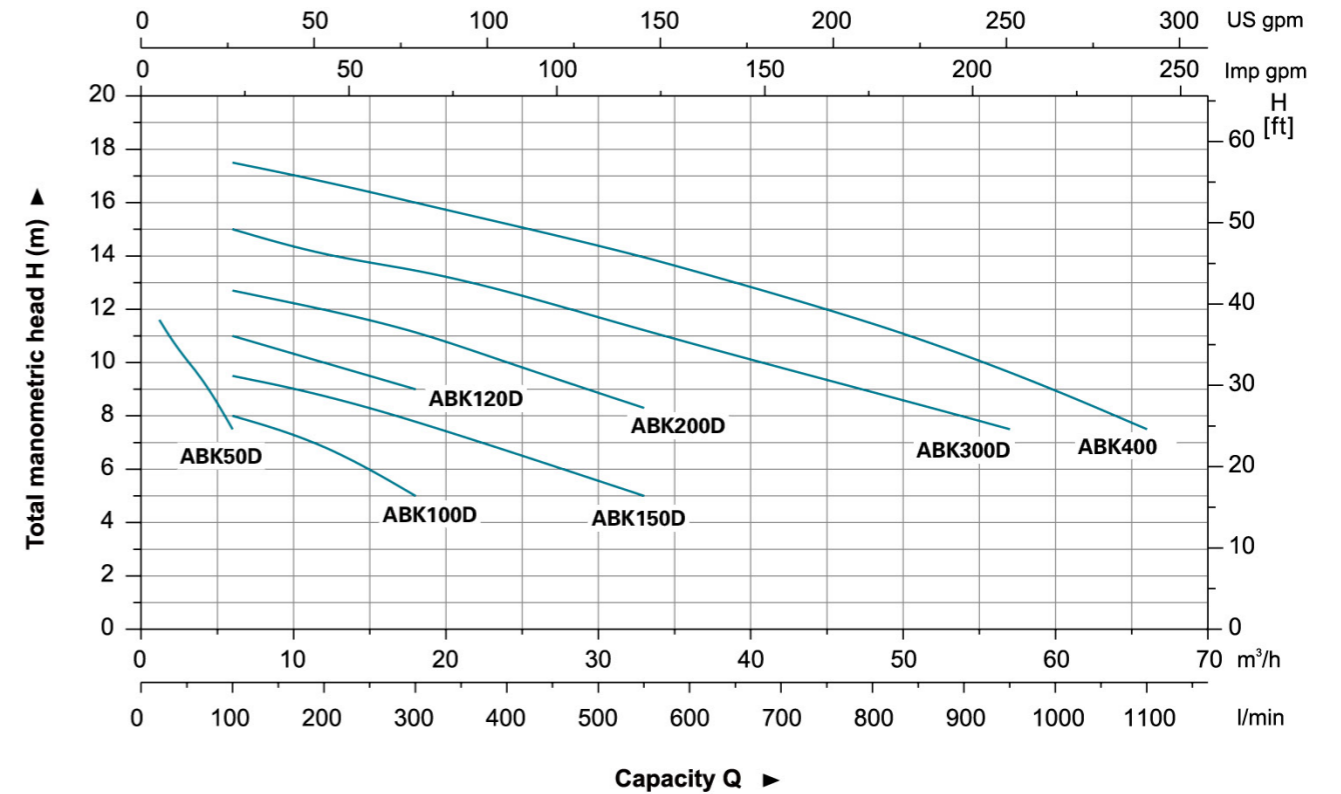

Materials Table

No.	Part	Material
1	Pump body	AISI 304
2	Impeller	AISI 304
3	Mechanical seal	Sic/Carbon
4	Bracket cover	AISI 304
5	Support	ZL102
6	Bearing	
7	Rotor	
8	Stator	
9	Terminal box	PC/ABS
10	Rear cover	ZL102
11	Fan	PP-GF30
12	Fan cover	08F

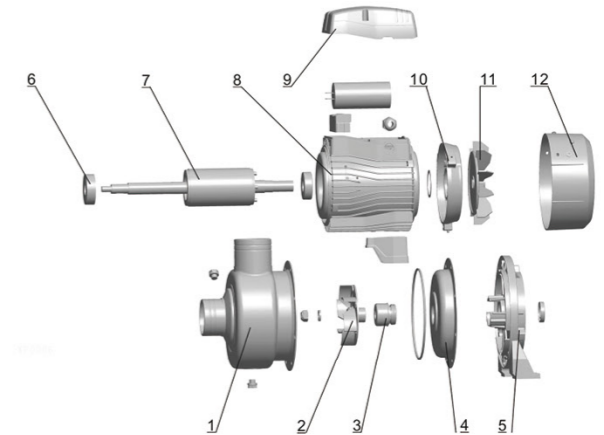

Package Information

Model	GW (Kgs)	L (mm)	W (mm)	H (mm)	Quantity (PCS/20 TEU)
ABK50(D)	6.5	310	190	215	2130
ABK100(D)	9.6	360	200	235	1566
ABK120(D)	10.7	360	200	235	1566
ABK150(D)	14	420	235	265	1032
ABK200(D)	15.7	420	235	265	1032
ABK300(D)	20.7	475	230	275	864
ABK400	21.8	475	230	275	864

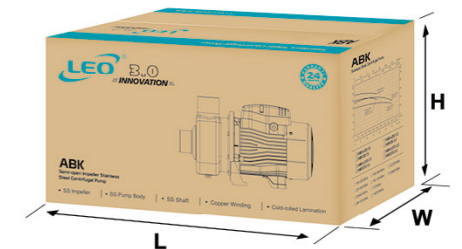



Application

- Water supply: filtration and transfer at waterworks, regional water supply and pressure boosting in main pipe
- Industrial pressure boosting: Water system, cleaning system
- Industrial water supply: boiler feeding, cooling system, air conditioning, transportation of light acid and alkali liquid
- Water treatment: distillation systems, separators, swimming pools
- Agricultural irrigation, petrochemical industry, medicine and sanitation, etc.

Operating Conditions

- Thin, clean, non-flammable and explosive, not containing the liquid with solid particles and fibers
- Liquid temperature: -15°C - +80°C
- Flow range: 0.7 - 132 m³/h
- Head range: 9 - 58 m
- Ambient temperature range: -15°C - +40°C
- Max. operation: 10 bar
- Altitude: up to 1000 m
- Liquid PH valve: 3 - 9
- Max. ambient temperature: +40°C

Motor

- IE2 Motor (IE3 motor available on request for power ≥ 9.2kw)
- Totally enclosed & fan-cooled
- Protection class: IP55
- Insulation class: F

Identification Codes

XZS 65- 50- 160/40

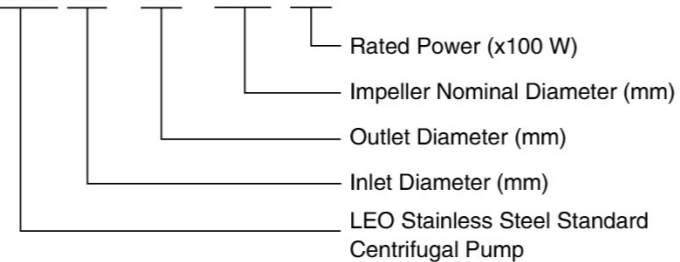

Accessories on Request



AISI304 Threaded flange

Flange gasket

Materials Table

1.1kw~7.5kw

No.	Part	Material	No.	Part	Material
1	Pump body	06Cr19Ni10	11	Fan	PP
2	Impeller	06Cr19Ni10	12	Fan cover	08F
3	O-ring	NBR	13	Rear cover	ZL102
4	Support	HT200	14	Nameplate	06Cr19Ni10
5	Oil seal		15	Stator	
6	Bearing		16	Terminal cover	ZL102
7	Rotor		17	Terminal board	
8	Stand	HT200	18	Cable holder	
9	Bearing		19	Support cover	06Cr19Ni10
10	Oil seal		20	Mechanical seal	

9.2kw~22kw

No.	Part	Material
1	Pump body	06Cr19Ni10
2	Impeller	06Cr19Ni10
3	O-ring	NBR
4	Support cover	06Cr19Ni10
5	Support	HT200
6	Motor	
7	Rotor	06Cr19Ni10/45
8	Nameplate	06Cr19Ni10
9	Guard plate	06Cr19Ni10
10	Mechanical seal	

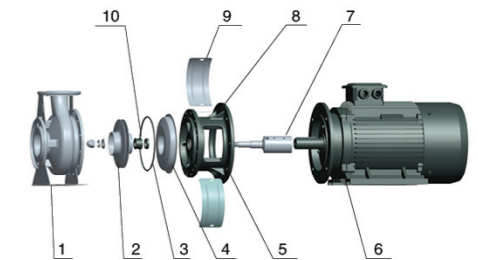
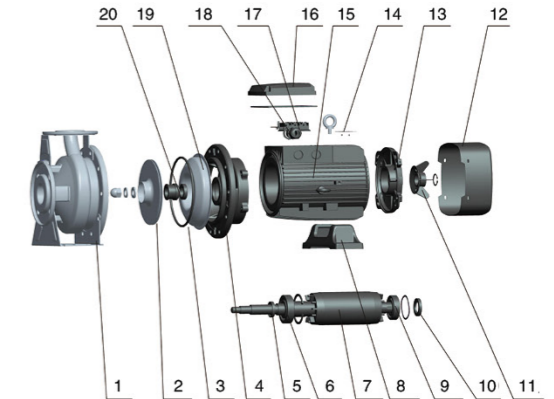

How to Read The Curve Charts

The thin curves indicate the duty range where long-time operation is not allowed

The bold curves indicate the duty range where long-time operation is permitted for best efficiency

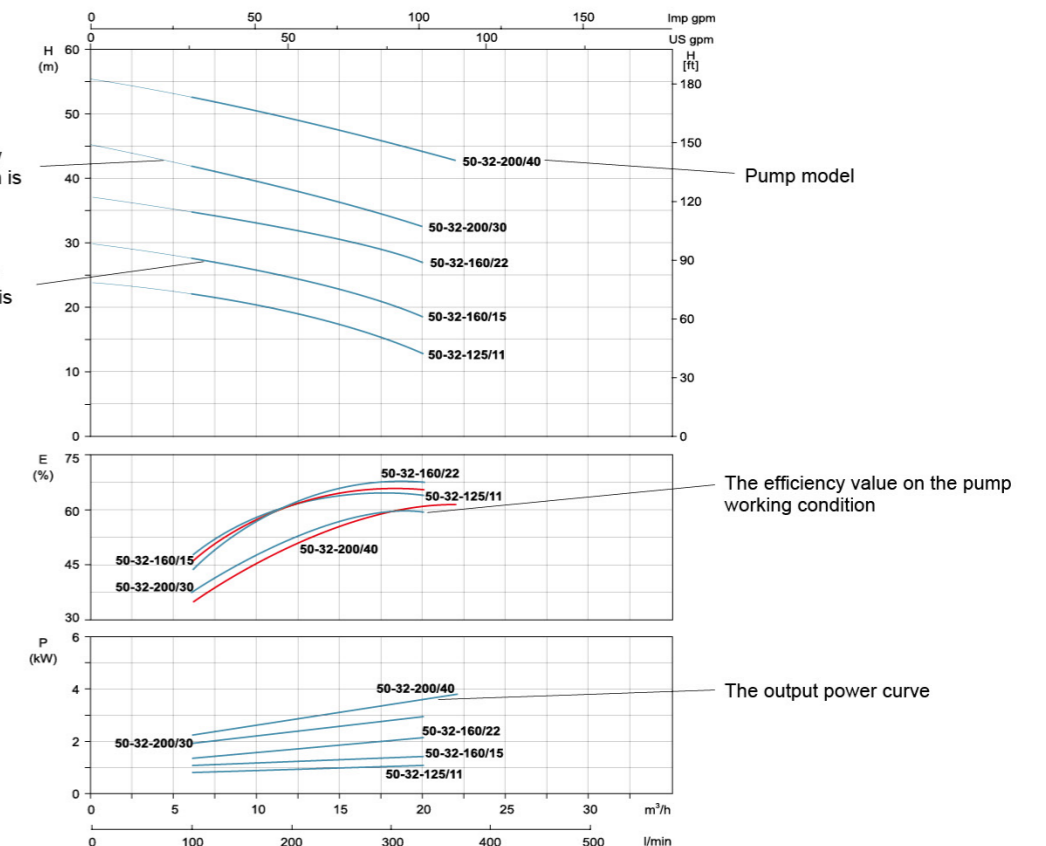

Ambient Temperature

Max. Ambient temperature: +40°C. Ambient temperature above 40°C, or installation at altitude of more than 1000 m above sea level, require the use of an oversize motor. Because of low air density and poor cooling effects, the motor output power P2 will be decreased. See the picture.

For example, when the pump is installed at altitude of more than 3500 m above sea level, P2 will be decreased to 88%. When the ambient temperature is 70°C, P2 will be decreased to 78%.

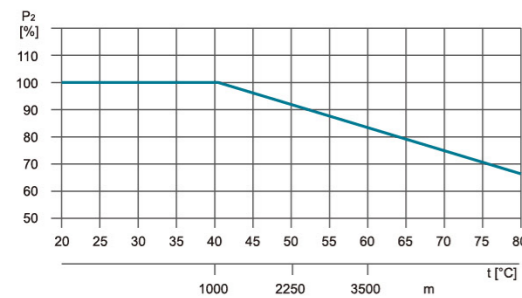

Technical Data

MODEL		Power		Q (m³/h)	Q=DELIVERY																				
GB5662 Standard	EN733 Standard	kW	HP		0	6	9	12	18	20	22	24	27	30	36	42	48	60	72	90	108	114	120	126	132
				Q (l/min)	0	100	150	200	300	333	360	400	450	500	600	700	800	1000	1200	1500	1800	1900	2000	2100	2200
XZS50-32-125/11		1.1	1.5		24	21.5	20.5	19.5	16	13	-	-	-	-	-	-	-	-	-	-	-	-	-	-	-
XZS50-32-160/15		1.5	2		29.5	27	26	25	21	18	-	-	-	-	-	-	-	-	-	-	-	-	-	-	-
XZS50-32-160/22		2.2	3		37	33.5	32.5	32	28.5	27	-	-	-	-	-	-	-	-	-	-	-	-	-	-	-
XZS50-32-200/30		3	4		45	41	40	38	34	32	-	-	-	-	-	-	-	-	-	-	-	-	-	-	-
XZS50-32-200/40		4	5.5		55	51	50	49	46	45	43	-	-	-	-	-	-	-	-	-	-	-	-	-	-
XZS65-50-125/15	XZS65-40-125/15	1.5	2		20	-	-	19	18	17	16.5	15	14	12.5	10	-	-	-	-	-	-	-	-	-	-
XZS65-50-125/22	XZS65-40-125/22	2.2	3		26	-	-	23.5	22.5	22	21.5	21	20.5	19.5	16.5	-	-	-	-	-	-	-	-	-	-
XZS65-50-160/30	XZS65-40-160/30	3	4		31	-	-	29	27.5	27	26.5	25.5	25	24	22	19	-	-	-	-	-	-	-	-	-
XZS65-50-160/40	XZS65-40-160/40	4	5.5		39	-	-	35.5	34.5	34	33.5	32.5	32	31	29	26	-	-	-	-	-	-	-	-	-
XZS65-40-200/55		5.5	7.5		47	-	-	43	42.5	42	41.5	41	40.5	39	37	33	-	-	-	-	-	-	-	-	-
XZS65-40-200/75		7.5	10		57	-	-	53	52.5	52	51	50	49	48	46.5	44.5	-	-	-	-	-	-	-	-	-
XZS80-65-125/30	XZS65-50-125/30	3	4		22.5	-	-	-	-	-	-	20	19.5	19	18.5	17.5	16	13	9	-	-	-	-	-	-
XZS80-65-125/40	XZS65-50-125/40	4	5.5		25.5	-	-	-	-	-	-	23	22.5	22	21.5	20.5	20	17	13.5	-	-	-	-	-	-
XZS80-65-160/55	XZS65-50-160/55	5.5	7.5		33	-	-	-	-	-	-	29.5	29	28.5	28	27	26	24	20	-	-	-	-	-	-
XZS80-65-160/75	XZS65-50-160/75	7.5	10		39	-	-	-	-	-	-	36	35	34.5	34	33.5	32.5	29	24	-	-	-	-	-	-
*XZS80-50-200/92	XZS65-50-200/92	9.2	12.5		53	-	-	-	-	-	-	-	-	48	47.5	46.5	44.5	39.5	34	-	-	-	-	-	-
*XZS80-50-200/110	XZS65-50-200/110	11	15		57.5	-	-	-	-	-	-	-	-	53	51	50.5	50	47	41	-	-	-	-	-	-
XZS100-80-125/40		4	5.5		20	-	-	-	-	-	-	-	-	-	17.5	16.5	15.5	14	12	7	-	-	-	-	-
XZS100-80-125/55		5.5	7.5		23	-	-	-	-	-	-	-	-	-	21.5	20.5	20	18	16	12	7.5	-	-	-	-
XZS100-80-125/75	XZS80-65-125/75	7.5	10		29	-	-	-	-	-	-	-	-	-	27.5	26.5	25.5	23.5	21.5	17.5	13	12	-	-	-
*XZS100-80-160/92	XZS80-65-160/92	9.2	12.5		33	-	-	-	-	-	-	-	-	-	-	31	30	28	26	23	-	-	-	-	-
*XZS100-80-160/110	XZS80-65-160/110	11	15		38.5	-	-	-	-	-	-	-	-	-	-	36	35	33	31	28	-	-	-	-	-
* XZS100-65-200/150		15	20		47	-	-	-	-	-	-	-	-	-	-	44	43	41	39	36	32	30	28	26	23
* XZS100-65-200/185		18.5	25		53	-	-	-	-	-	-	-	-	-	-	51	50	49	48	45	41	39	37	35	33
* XZS100-65-200/220		22	30		58	-	-	-	-	-	-	-	-	-	-	57	56	55	54	51	47	45.5	44	42	40

* =IE3 motor optional on request.

Characteristic Curves

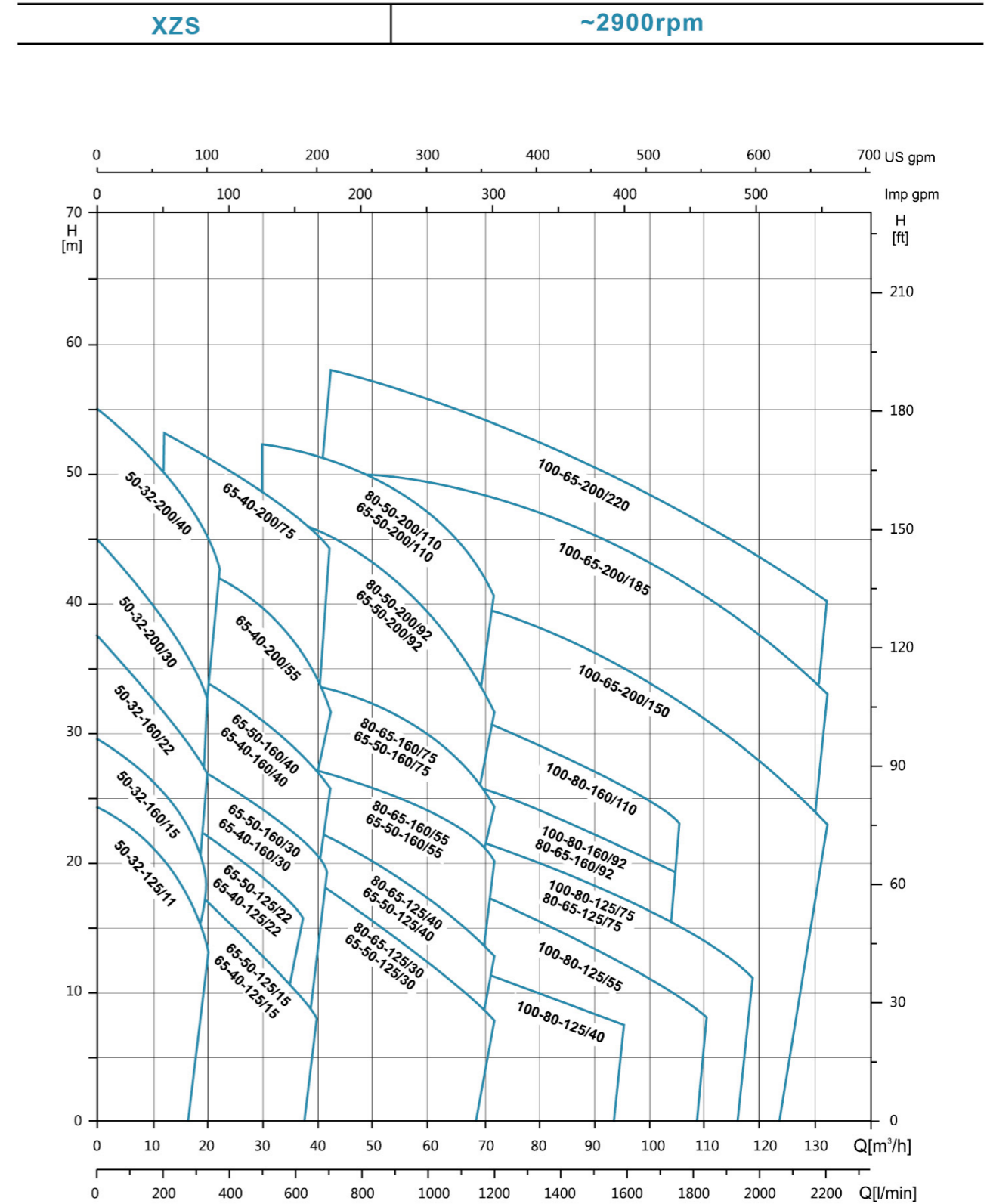

Hydraulic Performance Curves

Hydraulic Performance Curves

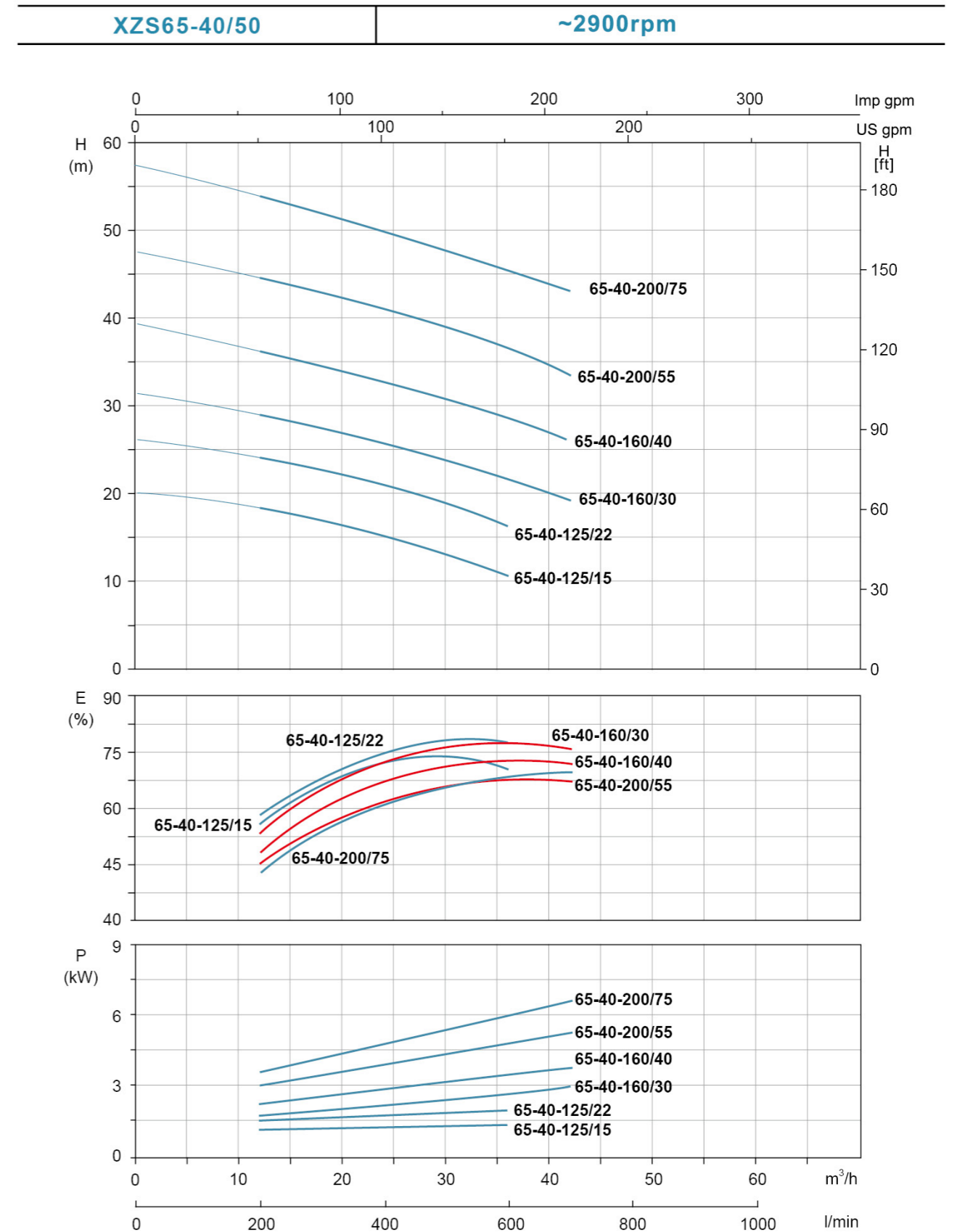
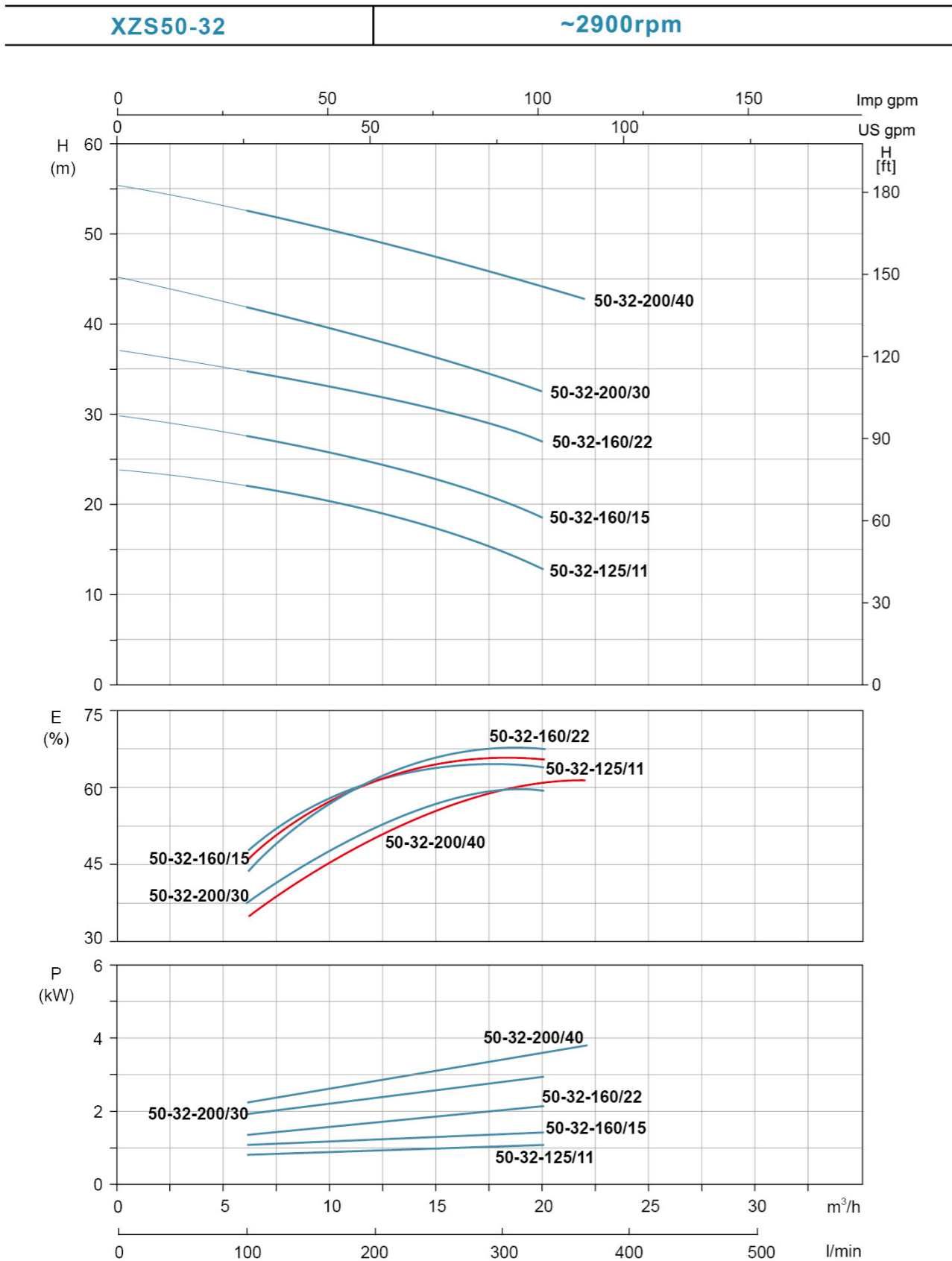

Hydraulic Performance Curves

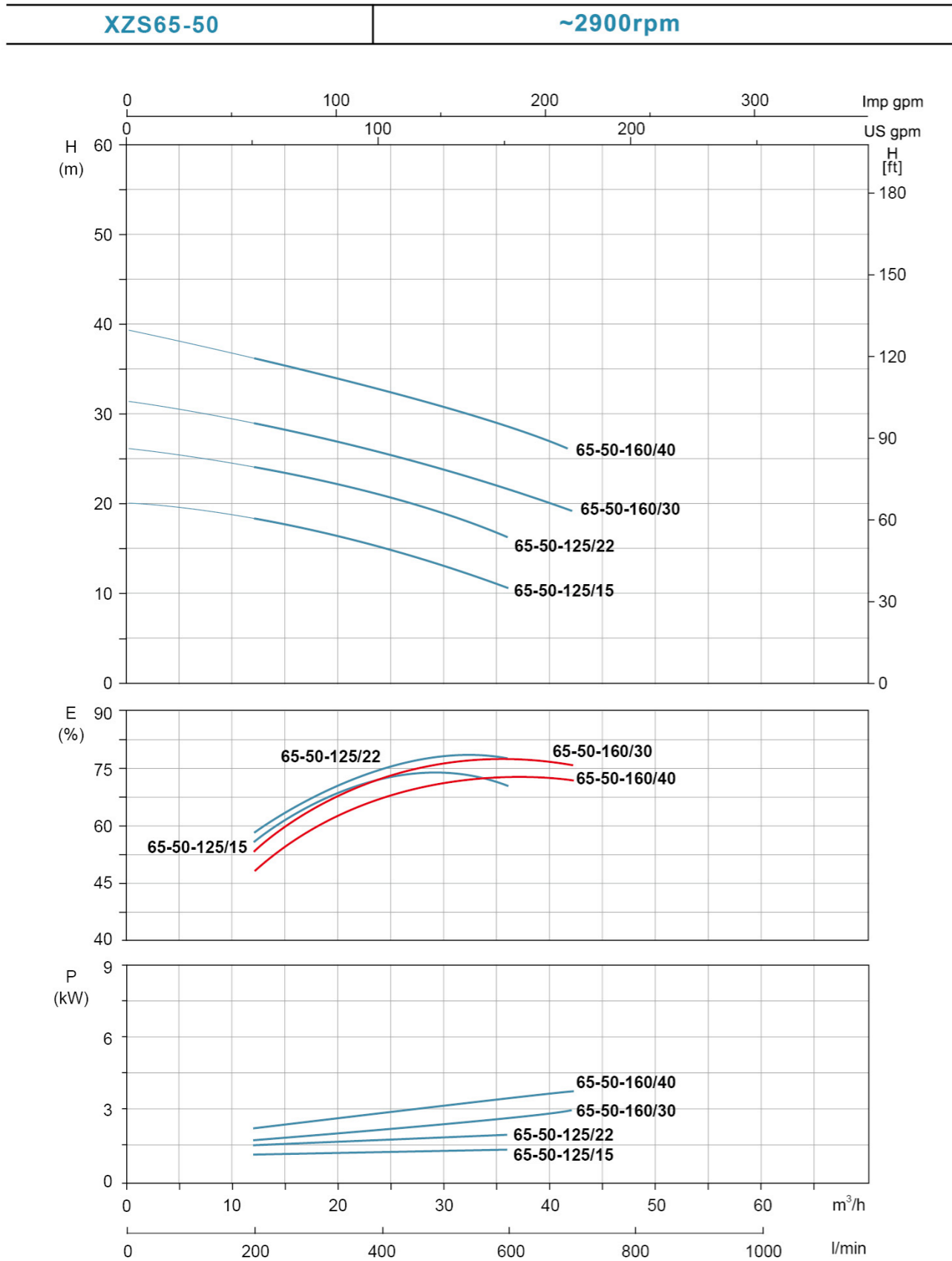

Hydraulic Performance Curves

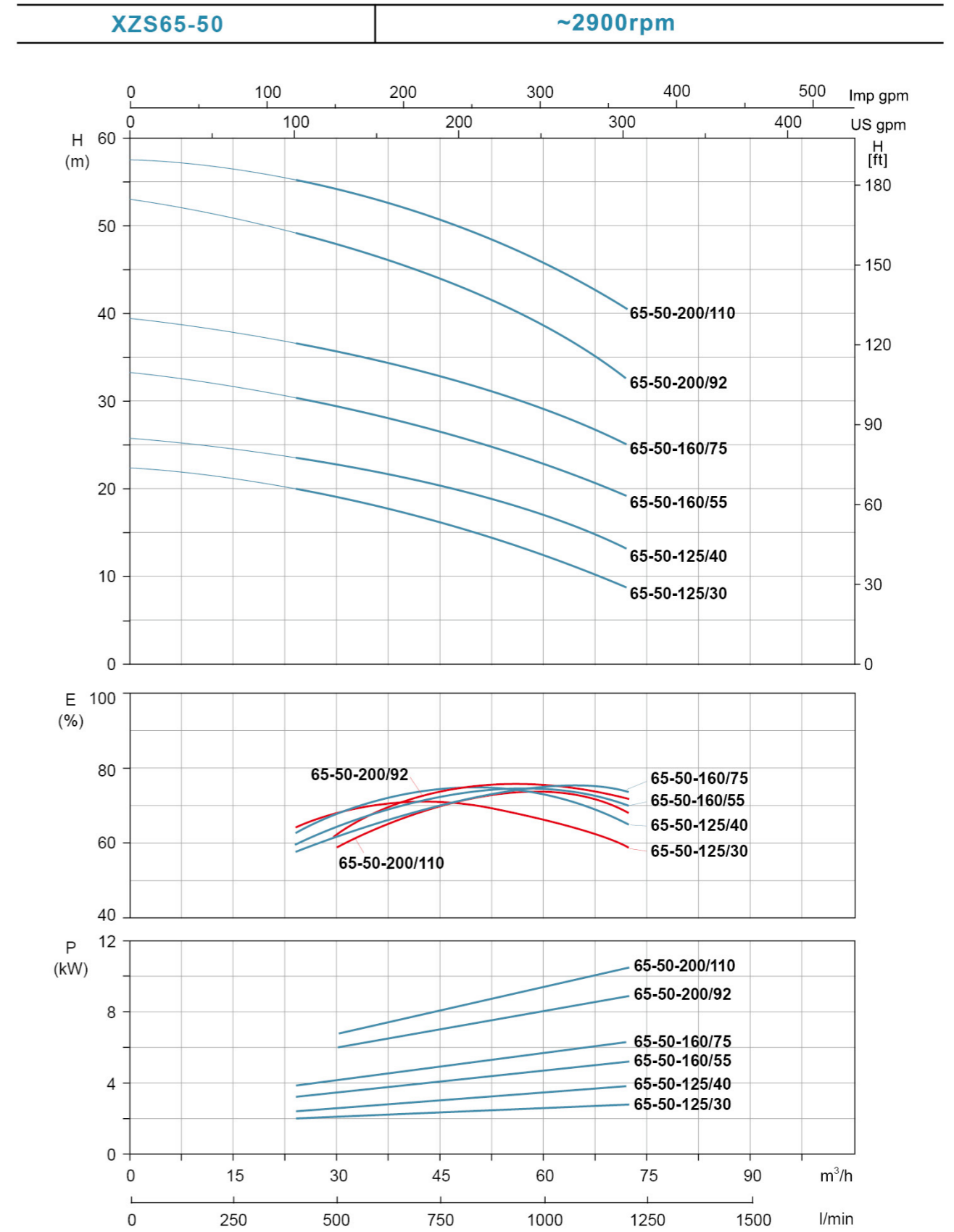

Hydraulic Performance Curves

Hydraulic Performance Curves

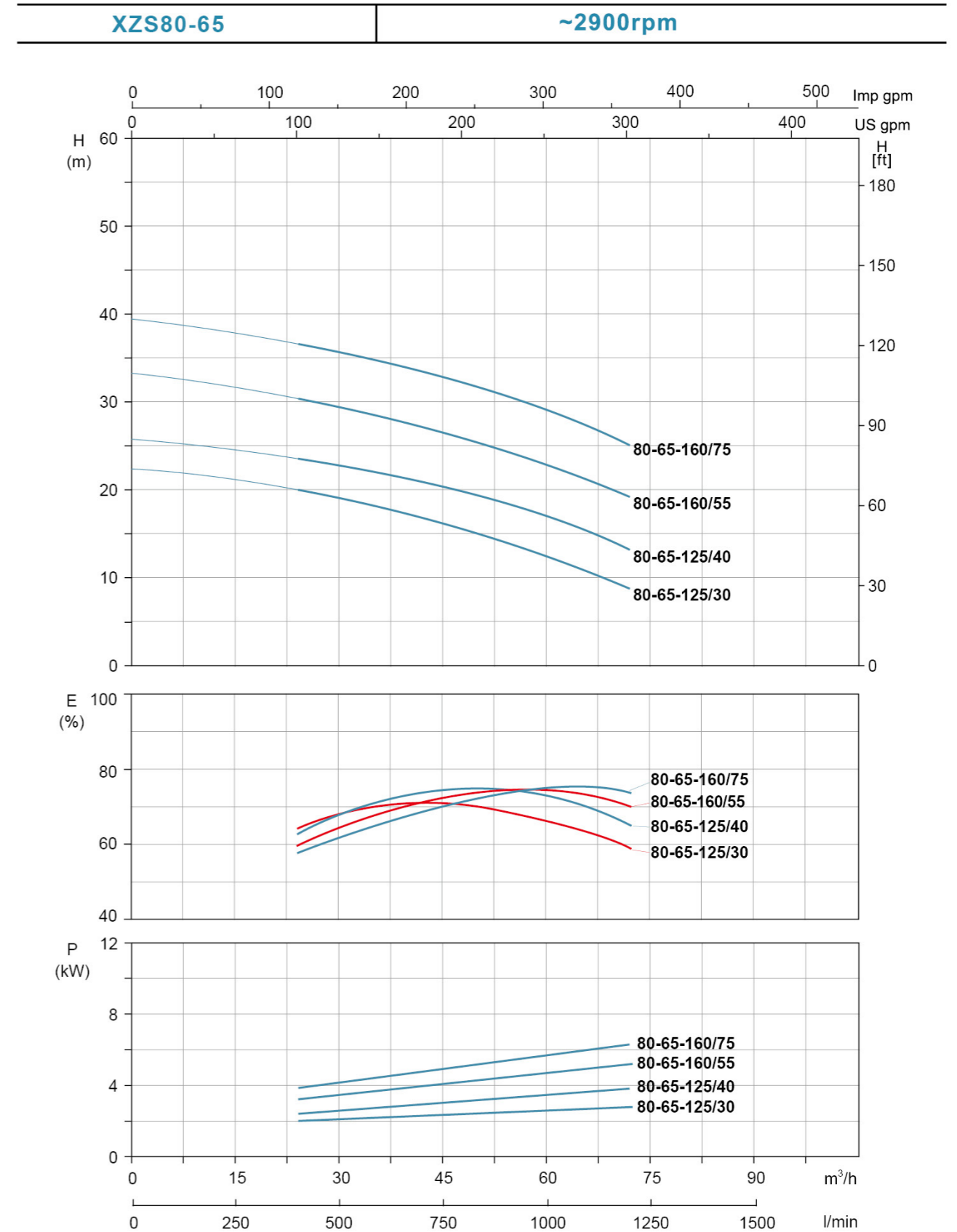
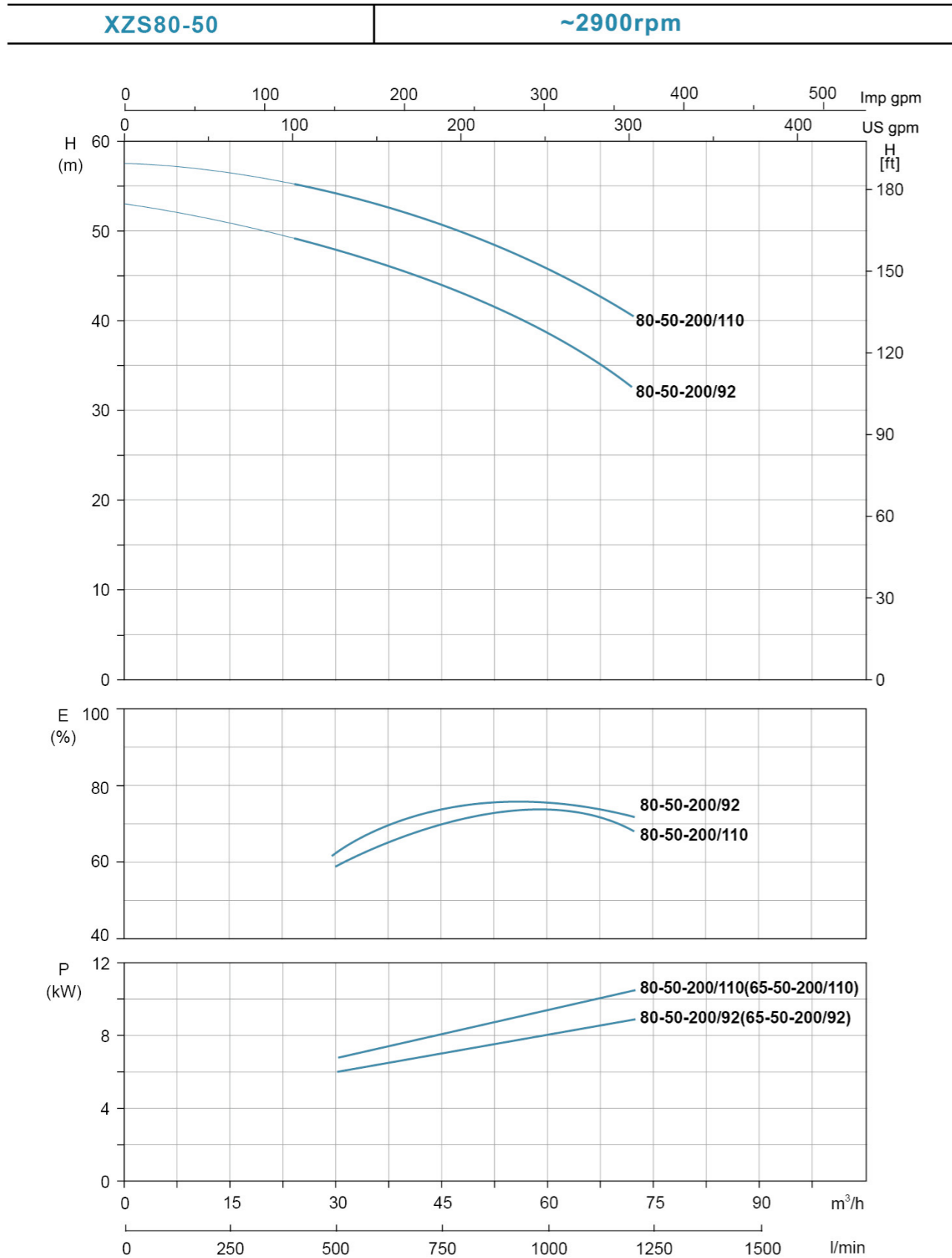

Hydraulic Performance Curves

XZS80-65

~2900rpm

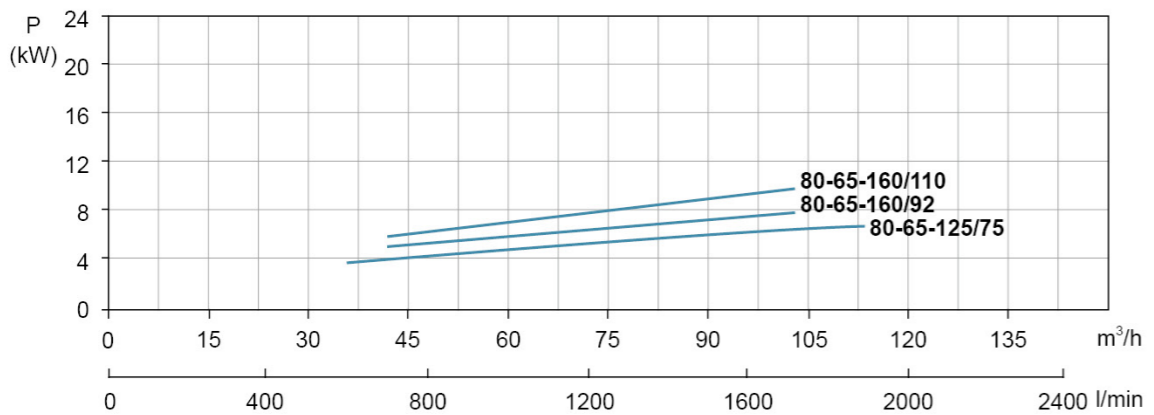
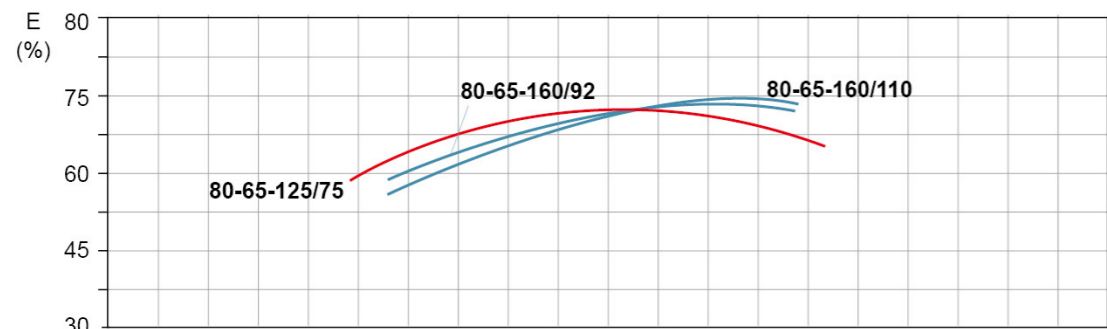
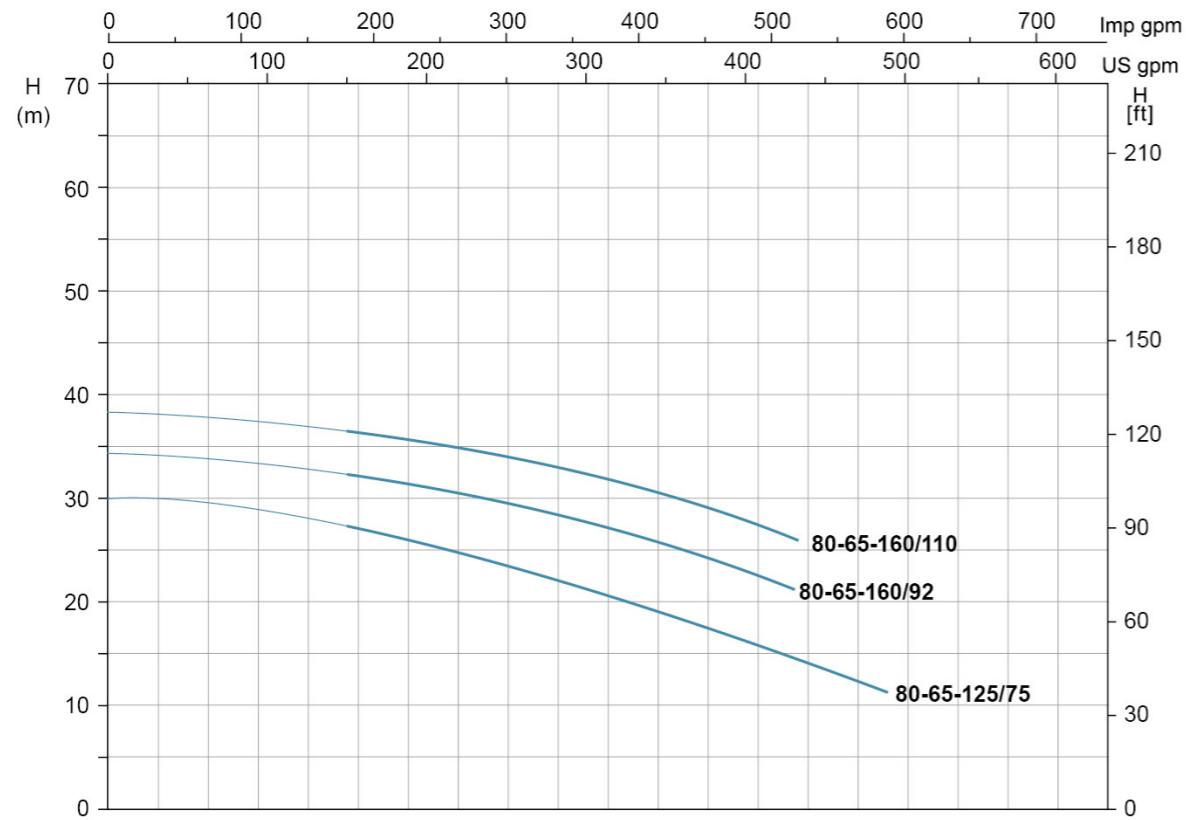

Hydraulic Performance Curves

XZS100-65

~2900rpm

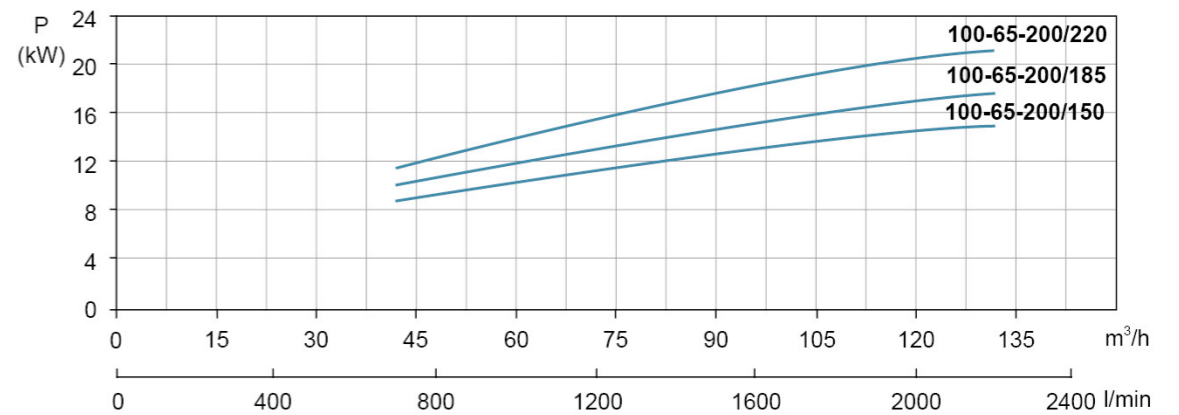
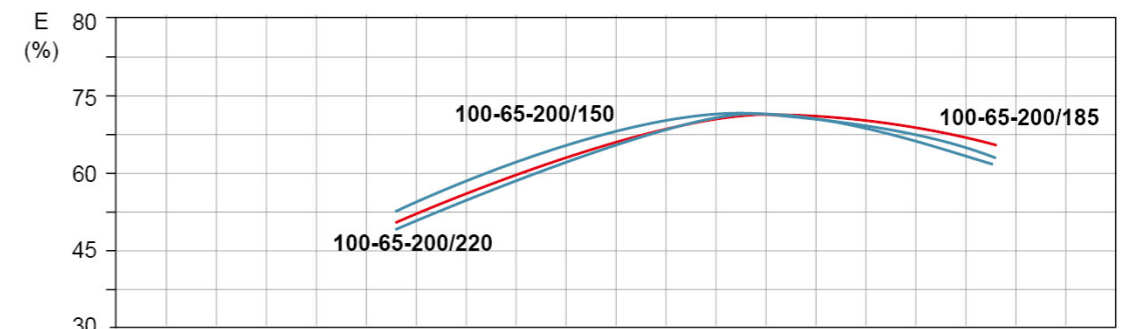
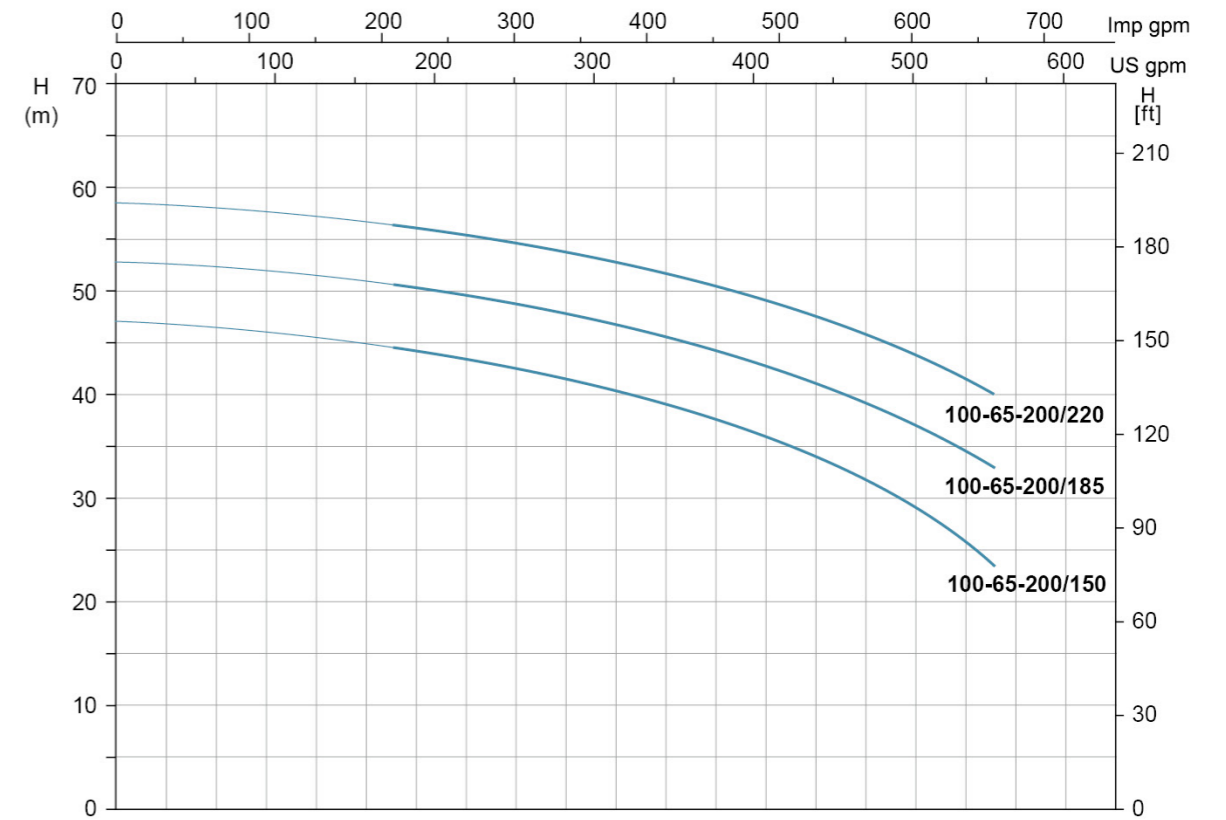

Hydraulic Performance Curves

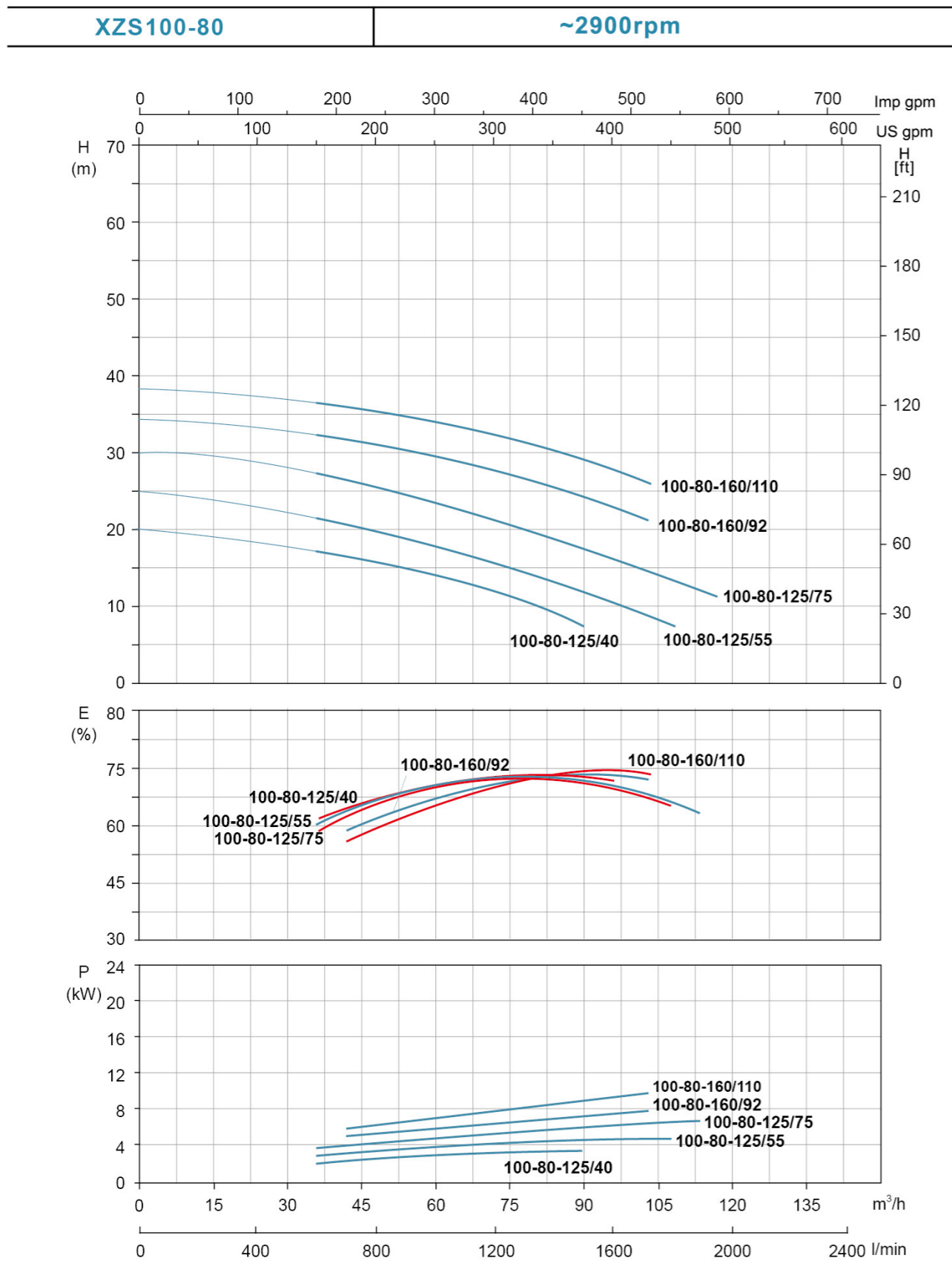

Installation Sketch

For model ≤ 7.5 kw

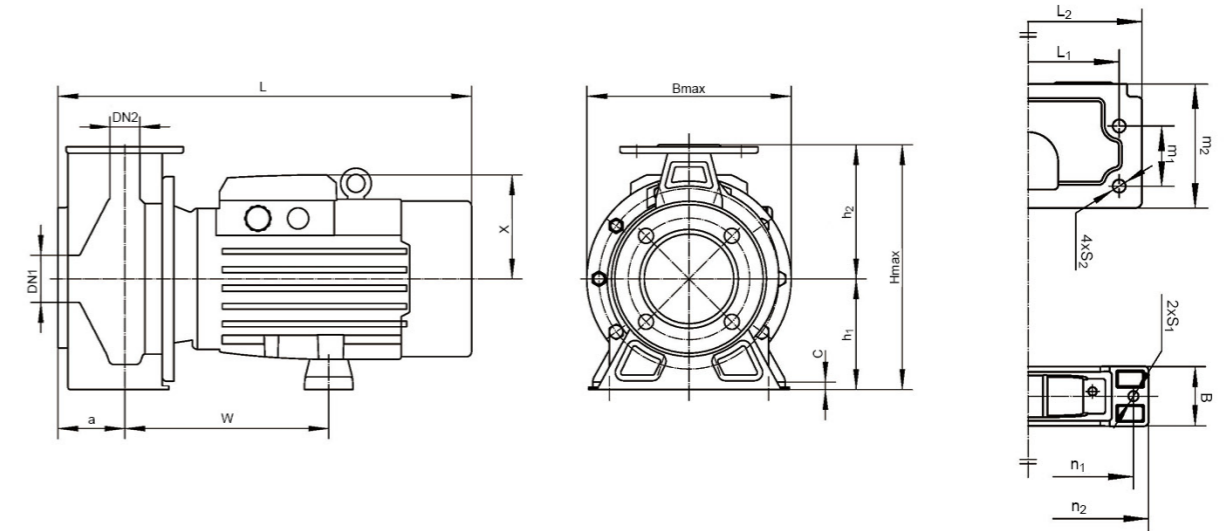

Model	DN1	DN2	a	w	L1	L2	m1	m2	n1	n2	h1	h2	2-S1	4-S2	B	C	X	Bmax	Hmax	L
XZS50-32-125/11	50	32	80	205	140	190	70	122	205	240	112	140	2-Ø12	4-Ø15	65	12	127	240	250	475
XZS50-32-160/15	50	32	80	207	190	240	70	122	205	240	132	160	2-Ø12	4-Ø15	65	12	127	244	292	477
XZS50-32-160/22	50	32	80	207	190	240	70	122	205	240	132	160	2-Ø12	4-Ø15	65	12	127	244	292	477
XZS50-32-200/30	50	32	80	244	190	240	70	124	225	260	160	180	2-Ø12	4-Ø15	75	15	124	295	340	492
XZS50-32-200/40	50	32	80	244	190	240	70	124	225	260	160	180	2-Ø12	4-Ø15	75	15	124	295	340	492
XZS65-50-125/15	65	50	80	205	160	210	70	121	205	240	112	140	2-Ø12	4-Ø15	65	12	127	240	252	475
XZS65-50-125/22	65	50	80	205	160	210	70	121	205	240	112	140	2-Ø12	4-Ø15	65	12	127	240	252	475
XZS65-50-160/30	65	50	80	244	190	240	70	123	225	260	132	160	2-Ø12	4-Ø15	75	15	124	260	292	492
XZS65-50-160/40	65	50	80	244	190	240	70	123	225	260	132	160	2-Ø12	4-Ø15	75	15	124	260	292	492
XZS65-40-200/55	65	40	40	246	212	265	70	146	245	280	160	180	2-Ø12	4-Ø15	70	15	142	295	340	563
XZS65-40-200/75	65	40	40	246	212	265	70	146	245	280	160	180	2-Ø12	4-Ø15	70	15	142	295	340	563
XZS80-65-125/30	80	65	65	254	190	240	70	158	225	260	132	160	2-Ø12	4-Ø15	75	15	124	260	292	522
XZS80-65-125/40	80	65	65	254	190	240	70	158	225	260	132	160	2-Ø12	4-Ø15	75	15	124	260	292	522
XZS80-65-160/55	80	65	65	256	212	265	70	150	245	280	160	180	2-Ø12	4-Ø15	70	15	142	280	340	573
XZS80-65-160/75	80	65	65	256	212	265	70	150	245	280	160	180	2-Ø12	4-Ø15	70	15	142	280	340	573
XZS100-80-125/40	100	80	80	256	212	280	95	155	225	260	160	180	2-Ø12	4-Ø15	75	15	124	280	340	524
XZS100-80-125/55	100	80	80	258	212	280	95	155	245	280	160	180	2-Ø12	4-Ø15	70	15	142	280	340	575
XZS100-80-125/75	100	80	80	258	212	280	95	155	245	280	160	180	2-Ø12	4-Ø15	70	15	142	280	340	575
XZS65-40-125/15	65	40	80	205	160	210	70	121	205	240	112	140	2-Ø12	4-Ø15	65	12	127	240	252	475
XZS65-40-125/22	65	40	80	205	160	210	70	121	205	240	112	140	2-Ø12	4-Ø15	65	12	127	240	252	475
XZS65-40-160/30	65	40	80	244	190	240	70	123	225	260	132	160	2-Ø12	4-Ø15	75	15	124	260	292	492
XZS65-40-160/40	65	40	80	244	190	240	70	123	225	260	132	160	2-Ø12	4-Ø15	75	15	124	260	292	492
XZS65-50-125/30	65	50	100	254	190	240	70	158	225	260	132	160	2-Ø12	4-Ø15	75	15	124	260	292	522
XZS65-50-125/40	65	50	100	254	190	240	70	158	225	260	132	160	2-Ø12	4-Ø15	75	15	124	260	292	522
XZS65-50-160/55	65	50	100	256	212	265	70	150	245	280	160	180	2-Ø12	4-Ø15	70	15	142	280	340	573
XZS65-50-160/75	65	50	100	256	212	265	70	150	245	280	160	180	2-Ø12	4-Ø15	70	15	142	280	340	573
XZS80-65-125/75	80	65	100	258	212	280	95	155	245	280	160	180	2-Ø12	4-Ø15	70	15	142	280	340	575

Installation Sketch

For model $\geq 9.2\text{kw}$

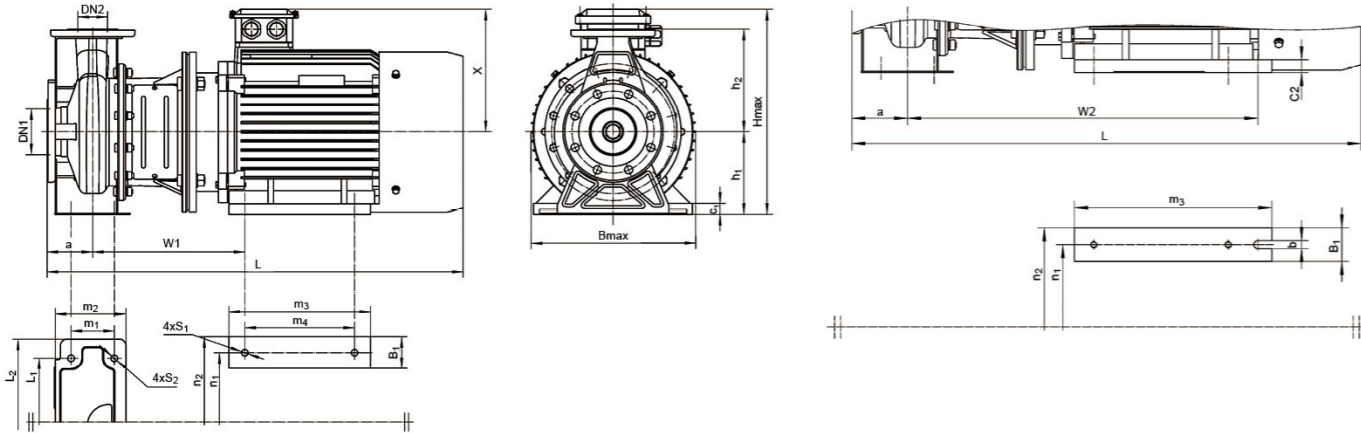

Model	DN1	DN2	a	w1	w2	L1	L2	m1	m2	m3	m4	n1	n2	h1	h2	4-S1	4-S2	B1	b	c1	c2	X	Bmax	Hmax	L
XZS80-50-200/92	80	50	100	314	-	212	265	70	146	210	260	254	320	160	200	4- Φ 14.5	4- Φ 14	65	-	20	-	260	350	420	816
XZS80-50-200/110	80	50	100	314	-	212	265	70	146	210	260	254	320	160	200	4- Φ 14.5	4- Φ 14	65	-	20	-	260	350	420	816
XZS100-80-160/92	100	80	100	321	-	212	280	95	155	260	210	254	320	160	200	4- Φ 14.5	4- Φ 14	65	-	20	-	260	350	420	823
XZS100-80-160/110	100	80	100	321	-	212	280	95	155	260	210	254	320	160	200	4- Φ 14.5	4- Φ 14	65	-	20	-	260	350	420	823
XZS100-65-200/150	100	65	100	-	581	250	320	95	155	310	-	254	314	180	225	-	4- Φ 14	60	14.5	-	20	260	350	440	823
XZS100-65-200/185	100	65	100	-	625	250	320	95	155	354	-	254	314	180	225	-	4- Φ 14	60	14.5	-	20	260	350	440	868
XZS100-65-200/220	100	65	100	334	-	250	320	95	155	311	241	279	355	180	225	4- Φ 14.5	4- Φ 14	70	-	22	-	280	355	460	913
XZS65-50-200/92	65	50	100	314	-	212	265	70	146	210	260	254	320	160	200	4- Φ 14.5	4- Φ 15	65	-	-	-	260	350	420	816
XZS65-50-200/110	65	50	100	314	-	212	265	70	146	210	260	254	320	160	200	4- Φ 14.5	4- Φ 15	65	-	-	-	260	350	420	816
XZS80-65-160/92	80	65	100	321	-	212	280	95	155	260	210	254	320	160	200	4- Φ 14.5	4- Φ 15	65	-	-	-	260	350	420	823
XZS80-65-160/110	80	65	100	321	-	212	280	95	155	260	210	254	320	160	200	4- Φ 14.5	4- Φ 15	65	-	-	-	260	350	420	823

Flange Dimensions

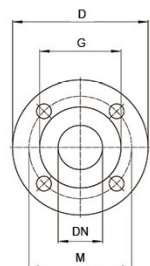

PN16 FLANGES

DN	D	M	G	Holes		Max. Thickness
				N	Φ	
Φ 32	140	100	76	4	18	14
Φ 40	150	110	84	4	18	14.5
Φ 50	165	125	99	4	18	15
Φ 65	185	145	118	4	18	16
Φ 80	200	160	132	4	18	18

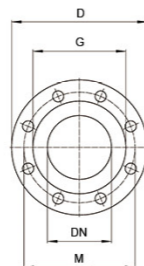

PN16 FLANGES

DN	D	M	G	Holes		Max. Thickness
				N	Φ	
Φ 100	220	180	152	8	18	18

General

The series of intelligent pressure boosting system BWS-HY is developed based on PID control technology, to control the pump pressure within a certain range according to the water consumption with features of complete functions, reliable quality, stable operation and easy maintenance.

About BWS

BWS, the abbreviation of Building Water System or Best Water System, implies the LEO's ambition to build up the image of best quality product range for water supply system in the market.

BWS series includes WG Non-negative Water Supply System, WX Water Non-negative Supply System, HY Constant Water Supply System and ZY Boosting Water Supply System. Together with WQ sewage pumps, XBD firefighting pumps, LPP in-line pumps and LEN end suction pumps, we have full range to satisfy the applications of secondary water supply, drainage, fire-fighting and HVAC.

Product Composition

The complete device is composed from a pump unit, a pressure tank, a pressure sensor, PID and accessories. If necessary, auxiliary pumps or pressure tanks can be added in the device.



Identification Codes

BWS - HY (E) 2LVS15-8 / LVS3-10

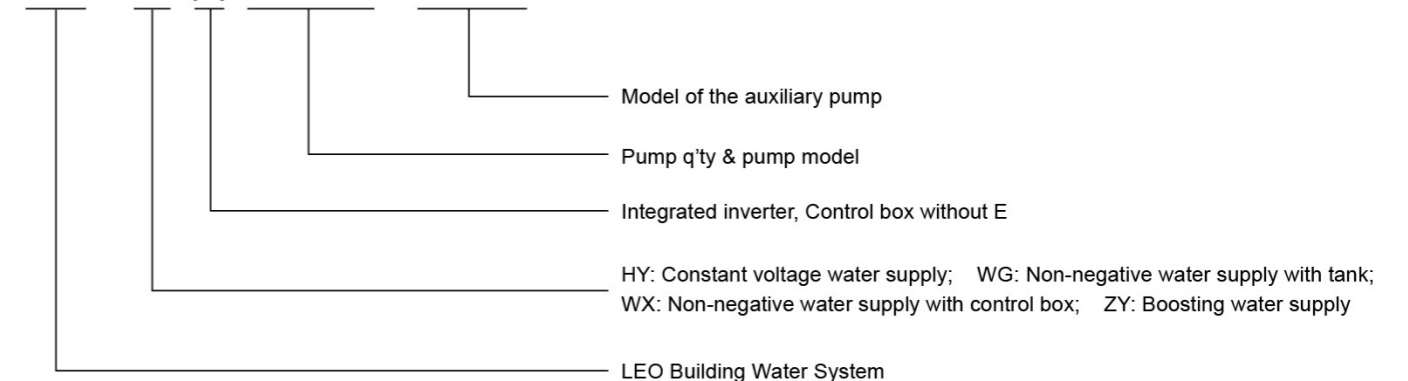

Working Principle

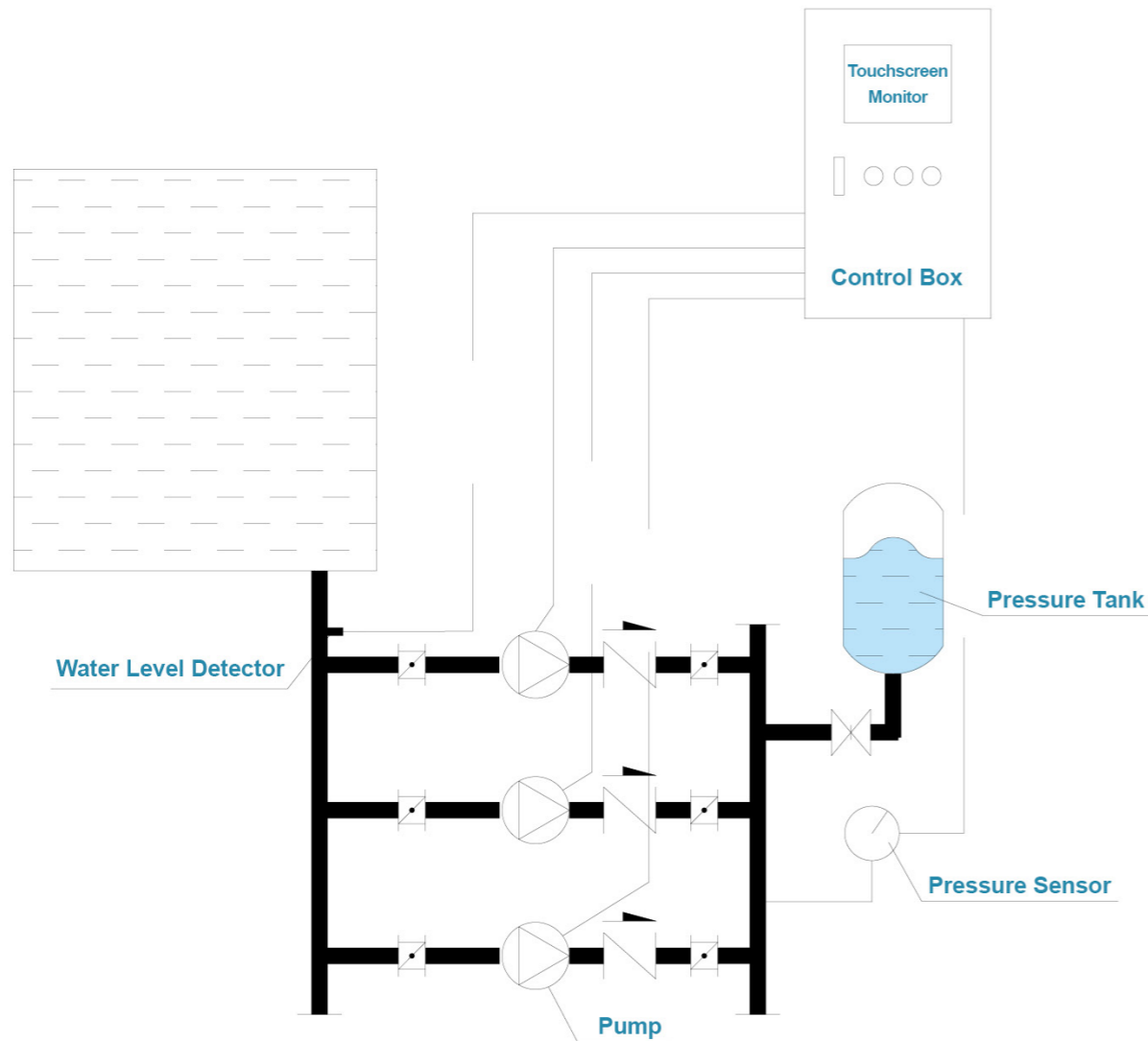

Product Overview

The pressure value on the pump outlet is set as a parameter in the water supply equipment. The output frequency is controlled by PID inverter and the rotating speed of pump motor is consequently adjusted to keep the water system pressure constant as the preset pressure value. When the water consumption increases, the frequency is increased accordingly to accelerate pump speed. On the contrary, when the water consumption reduces, the frequency is decreased to reduce the pump speed. In this way, a sufficient pressure (same as the preset value) and water supply (which fluctuates according to the water consumption of the users) in the entire network is guaranteed.

Product Features

This device features stable pressure, non-frequent operation, high efficiency, energy saving and low noise, which can be used to replace traditional high-positioned water tanks or water towers.

- 24 hours constant pressure and automatic activation of auxiliary pumps according to pressure signals
- Smooth start, which eliminates water hammer and extends the service life of motors and pumps
- Protection against under or over voltage, overcurrent, overheat, overpressure as well as no-load of water
- Optional functions available on customer's demand, such as motors in-turn running, sleep mode, etc.
- Digital PID control, which is better than PLC logical control
- Stable operation and easy handling due to high automation and intelligence level
- 100% factory tested with very low failure rate

Applications

- Communities, villas, office buildings, high buildings, hotels, restaurants, etc.
- Boilers (cold and hot water)
- Pressure boosting in water plant
- Industrial production
- Cooling water circulation system
- Fire fighting

Operating Conditions

- Power: 380 V, 50 Hz (60 Hz on request)
- Ambient temperature: 0 - 40°C, relative humidity up to 90%, no condensation
- Medium: Clean water or other liquids similar to water in physical and chemical properties
- PH value: 5 - 9
- Liquid temperature: 0 - 70°C
- Altitude: up to 1000 m, slope of the base up to 5 degree

Product Functions

- **Constant pressure water supply**
The pressure of pipe network is controlled within a certain range.
- **Alternative operation**
The pumps work by turns according to the present timing. The operation time for each pump is roughly equal to prolong the service life of the device.
- **Timing function**
Working pressure values in different time can be set to meet the demand of water supply.
- **Sleep mode**
The device goes into sleep mode for energy-saving during the night or the water consumption is very few.
- **Automatic wake-up**
When the pressure of water network reduces to the preset value, the device will be waken up automatically and start to operate.
- **Automatic reset**
In the event of an inverter failure, the controller will reset the inverter automatically. If the reset time is more than preset number, a display of inverter failure will be generated by the system. Maintenance of the inverter is necessary.

- **Automatic operation at power frequency**

In the event of malfunction of the inverter or pressure sensor, the device will operate at power frequency automatically to ensure water supply and sound an alarm.

- **Manual/Automatic operation**

The device has two operation modes (manual and automatic) for selection.

- **Automatic start/stop**

In case of low water level in the water source, the device will stop the working pumps and sound alarm. When the water level recovers, the device will restart automatically.

- **Overload protection**

When the current of the motor exceeds the preset value for a specified period of time, the controller will shut down the related pump and sound an alarm.

- **Water-load protection**

If the device has no water or high gas content for a specified period of time, the controller will shut down the entire device. The device runs automatically again, when the water is recovered and the gas inside is exhausted.

- **Overpressure protection**

When the pressure is higher than preset value for some reason during operation, the device will be shut down automatically to avoid any damage of pipelines.

- **Low pressure protection**

When the pressure of the pipelines is lower than preset value, the device will judge it as a leakage on the pipe network and will be shut down automatically to save the water.

- **Alarm function**

Any fault during operation will be alarmed and displayed on the LCD screen automatically.

- **Information storage**

All alarm information can be saved in the controller for inspection.

- **Password setting**

The device is protected by a password. Only the administrator is authorized to change the parameter.

- **Reset of parameter values**

In case of abnormal operation due to change of parameter values by users, the values can be reset to the factory default settings for safe operation.

- **Overvoltage & Undervoltage protection**

If the voltage is 10% higher or lower than normal voltage, the device will stop working to avoid any damage of the components.

- **Phase sequence and phase-lacking protection**

In case of wrong phase sequence or lack of phase at power supply, the inner control components will protect the device and ensure it's normal operation.

- **Remote monitoring**

The device can be equipped with a remote monitoring system.

Main Parts

A standard BWS-HY system is composed of 2 - 6 pcs of pumps which are installed on the same base in parallel and necessary accessories as well as a control box (A pressure tank must be included during installation).

No.	Description	Q'ty
1	Vertical Multistage Pump	2 - 6 pcs
2	PID Control Box	1 pc
3	Base	1 pc
4	Main Inlet Pipe	1 pc
5	Main Outlet Pipe	1 pc
6	Non Return Valve	1 pc per pump
7	Ball Valve or Butterfly Valve	2 pcs per pump
8	Water Level Detector	1 pc
9	Pressure Sensor	1 pc
10	Pressure Tank	1 pc



Pump Unit

The key operation part of the water supply system. Stainless steel pipelines, flanges, valves and pumps are assembled by unique swing welding technology.

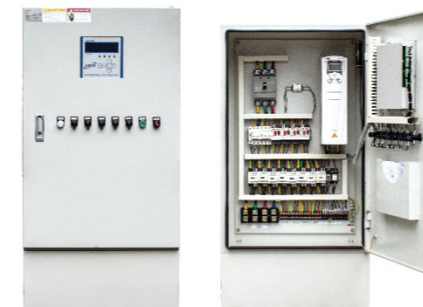

PID Control Box

The key control part of the water supply system. The inverter, circuit breaker, relay, contactor, alarm device, signal indicator and remote monitoring device are integrated with reasonable layout inside the control box.



Pressure Tank

A sealed pressure vessel made of SS 400 or STS 307 for water storage and elimination of water hammer. The membrane is from BUTYL or EPDM. The tank has the effect of compensation of water and pressure, when the system shuts down or the flow becomes small.

Pump Range



● Peripheral Pump



● Self-Priming Peripheral Pump



● Jet Pump



● Jet Pump for Deep Wells



● Centrifugal Pump



● Multistage Centrifugal Pump



● Self-Priming Centrifugal Pump



● Stainless Steel Multistage Centrifugal Pump



● Stainless Steel Centrifugal Pump



● Submersible Pump



● Stainless Steel Submersible Pump



● Stainless Steel Submersible Sewage Pump



● Flexible Shaft Pump



● Domestic Lifting Station



● Pool Pump



● Garden Submersible Pump



● Garden Jet Pump



● Pressure Booster System



● Fountain Pump



● Standard Centrifugal Pump



● Submersible Borehole Pump



● Gasoline/Diesel Water Pump



● Booster Pump/Circulation Pump

Pump Range



● Submersible Sewage Pump



● Submersible Sewage Pump



● Submersible Dewatering Pump



● Submersible Slurry Pump



● Stainless Steel Vertical Multistage Pump



● Stainless Steel Horizontal Multistage Pump



● Semi-open Impeller Stainless Steel Centrifugal Pump



● Stainless Steel Standard Centrifugal Pump



● Pressure Booster System



● Vertical In-line Pump



● Bare Shaft End Suction Centrifugal Pump



● End Suction Centrifugal Pump